



# Institutional Gateway Course Success Action Plans

Pursuant to the recommendation of the Task Force on Gateway Mathematics Success, in June 2015 the Board of Regents revised its placement policy (*Title 4, Chapter 16, Section 1*) to require placement of students directly into college-level courses based on benchmark scores on college readiness assessments (including the ACT and SAT). For those students who do not meet the benchmark scores on the college readiness assessments, each NSHE institution must develop an assessment and placement policy that ensures students who place at high school or above levels have an opportunity to enroll in and complete gateway college courses in mathematics and English within one academic year (or three semesters for a student on a STEM path who places at the high school level in mathematics). The institutional plans developed for the purpose of implementing the Board's policy are compiled here.

**UNLV**

**Institutional Gateway Course Action Plan**



February 5, 2016

Revision: April 11, 2016 responding to NSHE Request

**Revision April 25, 2016**

TO: Crystal Abba  
NSHE Vice Chancellor for Academic and Student Affairs

FROM: Dr. Carl Reiber  
Senior Vice Provost

RE: UNLV Gateway Course Success Action Plan

---

The following document contains UNLV's action plan requirements for implementing the provisions of Title 4, Chapter 16, Section 1. The action plan addresses the five areas requested: policy framework, enforcement measures, advising and student outreach plan, communication strategies, and data benchmarks.

**Focus One (Elements 2a): Initial Placement of Students into English and Mathematics: Exemption from Remedial Instruction**

**Policy Framework**

*a. Exemption from Remedial Instruction. Degree-seeking students who meet or exceed the minimum English or mathematics scores on any one of the college readiness assessments listed below must be placed into a college-level course in that subject and are exempt from being placed into any form of remedial instruction in that subject provided that the student:*

- i. Was continuously enrolled in an English course and a mathematics course in his or her senior year of high school unless an exception is approved on a case by case basis by an NSHE institution; and*
- ii. Enrolls in an NSHE institution after high school in any term (summer/fall/ winter/spring) during the academic year following high school graduation. Institutions may use other factors including high school transcript, grade point average, or additional testing to determine the appropriate first college-level course. Institutions are not required to honor initial placement decisions pursuant to this subsection for students who fail to remain continuously enrolled in required mathematics and English courses until the core mathematics and English requirements are completed.*

### **UNLV Policy Framework Actions & Timeline:**

UNLV institutional policy and protocol addresses placement into math and English via ACT/SAT tests, ALEKS placement system for UNLV math courses, Smarter Balanced, and PARCC scores as outlined within the College Readiness Assessment scores rubric. The pertinent section of Title 4, Chapter 16, Section 1 presently suggests that completion of four years of high school math and immediate enrollment into an NSHE institution following high school graduation could potentially serve as an equivalent “placement tool” into credit-bearing mathematics. If this is the case, UNLV will need to change transcript analysis for new freshmen at the point of admission. At this moment in time, Admissions transcript evaluators arrive at admissions decisions based on the analysis of three units of high school mathematics. Then, the MyUNLV system is populated with test score information that informs math course designation and English course designation for the administrative enrollment initiative “block scheduling” for new students.

### **UNLV Enforcement Measures:**

By Fall 2016, the Senior Vice Provost staff will work with the Associate Vice President for Enrollment Services to change the policy to include four years of high school mathematics as an equivalent placement tool into credit-bearing math and English (see note below 1 and 2). Once the change to policy has been completed, the Assistant Vice Provost for Retention, Progression & Completion will work with the Director of Admissions to ensure that new student queries by college include the level of high school math and English completed by new freshmen. This enforcement measure will be in place by Fall 2016.

1) Taking four years of mathematics will not be considered sufficient for placement into a credit-bearing mathematics class. For those students that do not meet the qualification standards for exemption from remediation, it is imperative they take an appropriate 12th grade experience in mathematics that helps them achieve, if possible, college credit status by the time of first matriculation at UNLV.

2) UNLV encourages every high school student to take four full years of mathematics in high school. We are not requiring four years of high school mathematics for all students, just those that do not qualify for a credit-bearing placement according to UNLV criteria outlined by ACT, SAT, ALEKS, PARC, or SBAC scores.

### **UNLV Advising and Student Outreach Plan:**

Once Admissions has implemented the policy change and added the level of high school math and English completion to the new admit queries, the office of Retention, Progression & Completion will train UNLV academic advisors to scan for this variable as a method for placement into English and math. In addition, the Associate Director of Undergraduate Advising Practice will work with Lumina (as UNLV’s representative in leadership of academic support strategies) to discuss the implementations strategies and possibilities for the Clark County high school community. In terms of reaching out to students, this information will be included in the welcome letter from academic advising centers to new students. This communication piece follows the letter of admission by approximately four weeks.

### **UNLV Communication Strategies:**

During summer 2015, staff meetings invitations will be extended to those units who need to know about this policy such as admissions, advising, the Math Learning Center, departments, faculty, math and English instructors, etc. In addition, UNLV will create a campus-wide campaign for students (visible signs across the university and a pop-up message in MyUNLV) reminding them to work with an academic advisor to determine highest level of placement into math and English courses.

### **Focus Two (Elements 2b & 2c)**

#### **Placement of Students Without an Exemption from Remedial Instruction**

*For degree-seeking students who have not met the English or mathematics college readiness assessment score on one of the tests in subsection a or who have not taken any of the tests in subsection a, institutions must develop an assessment and placement policy that ensures students who place at high school or above levels have an opportunity to enroll in and complete gateway college courses in mathematics and English within one academic year. The assessment and placement policy may use multiple measures, including, but not limited to placement exams; high school GPA; course selection and performance in the senior year of high school; and intended postsecondary program of study to determine appropriate placement into one the following options:*

- i. Placement into college-level courses without any additional academic support or remediation;*
- ii. Placement into a co-requisite course where academic support is provided to students while enrolled in college-level gateway courses;*
- iii. Placement into a single semester of remedial education that is followed by either a gateway college-level course or co-requisite gateway course option; or*
- iv. For students who are seeking a STEM (science, technology, engineering or mathematics) degree or program of study that requires college algebra or precalculus and who place at the high school Algebra 1 level (e.g. Math095), placement into a three-semester sequence culminating in the gateway college algebra course. The sequence may include co-requisite coursework.*

*c. Institutions may establish alternative pathways to those described in subsection b for those degree-seeking students whose mathematics or English skills are below the high school level as established by the institution's assessment and placement policy set forth in subsection b.*

### **UNLV Policy Framework Actions & Timeline:**

UNLV students in categories 2b and 2c have two options for alternate progression in math at this point, the ALEKS placement exam implemented by the Math Learning Center or completion of the one-semester bridge course implemented by the Academic Success Center. By completing the placement exam, students may “land” in Math 95 and this would require beyond one year for gateway math completion. However, by way of the ALEKS exam, students may place into Math 95, but with supplemental instruction and math support within the program, they can advance to a higher-level mathematics.

In terms of UNLV English placement, the department of English has implemented a two-semester stretch course, ENG101E & ENG101F. The purpose of this course is to advance students who place below test scores in English to and through credit-bearing English during the first academic year.

**UNLV Enforcement Measures:**

- UNLV will continue to enhance the ALEKS placement system during Spring 2016 and beyond.
- The Mathematics Learning Center is working on the creation of a bridge course for a one-semester version of Math 95 and Math 96 by Fall 2016.
- UNLV will continue to utilize the stretch course, ENG101E & ENG101F, for students to accomplish remediation skills through to the point of completion of the gateway English during the first year of enrollment.
- The Mathematics Learning Center is seeking to work with the Department of Mathematical Sciences in order to create co-requisite versions of Math 120 and Math 124 that will allow students “on the cusp” of qualifying for regular credit-bearing classes to engage in remediation as needed while still registered for a credit-bearing experience.
- The Mathematics Learning Center is seeking to work with the Department of Mathematical Sciences in order to restructure the Math 120 credit-bearing course to use the prerequisite of Math 95 rather than Math 96. This will allow more efficient and timely access to the credit-bearing course for those majors requiring Math 120 for their degree programs.

**UNLV Advising and Student Outreach Plan:**

- At the point of New Student Orientation, academic advisors are communicating the option for ALEKS to students. In addition, the Academic Success Center offers math bridge each semester. This provides students with the ability to move through an intensive math semester in order to place into credit-bearing mathematics.
- The department of English works closely with the UNLV colleges and advising centers and the Office of Retention, Progression & Completion to offer the appropriate number of sections of ENG101E and ENG101F to meet the demand for new students on a semester-by-semester basis.

**UNLV Communication Strategies:**

The UNLV Math Learning Center and the UNLV Academic Success Center are collaborating on a flyer/postcard document for New Student Orientation and other opportunities for outreach. The information will equip students with alternate options if they have placed into Math 95 or 96. The goal of this flyer is to direct students to Bridge, ALEKS, or the math department placement test. Also, the UNLV Math Pathways document is an effective communication tool for academic advisors as they assist students in reaching and completing their gateway math course. This document will be updated and shared across campus units as any information is changed.

The department of English will continue to work closely with the UNLV colleges and advising centers and the Office of Retention, Progression & Completion to offer the appropriate number of sections of ENG101E and ENG101F to meet the demand for new students on a semester-by-semester basis.

### **Focus Three (Number 3)**

**Unless an institutional exception is made, all degree-seeking students must be continuously enrolled in appropriate mathematics and English courses until the institutional core curriculum mathematics and English requirements are completed.**

### **UNLV Policy Framework Actions & Timeline:**

Since Fall 2012, UNLV freshmen have been “block enrolled” into the math and English courses by test scores or by placement exam. This is a process that has transitioned into an unofficial policy. By Fall 2016, UNLV will begin to enroll students in the appropriate course based on scores and/or completion of four units of high school mathematics and/or English.

### **UNLV Enforcement Measures:**

UNLV academic advisors are required to register UNLV freshmen into the appropriate level of math and English at the point of block enrollment during New Student Orientation. (Note that academic advisors will have, for the first time, an ACT score for every incoming Nevada student. This will provide us with a benchmark. By Fall 2016, academic advisors will be officially required to enroll students in the appropriate math and English courses. If they fail to pass or withdraw from either or both courses, an academic advising hold will be placed on the student’s record. This will force the re-enrollment into the appropriate math and/or English during the second semester.

### **UNLV Advising and Student Outreach Plan:**

Beginning in Fall 2016, a query will be generated by college per semester to determine student progress through math and English. Students will be communicated with via Student Success Collaborative Campus to ensure compliance and progression to gateway math and English by the end of the first academic year.

### **UNLV Communication Strategies:**

UNLV Admissions staff will communicate the significance of testing at the high school level for higher placement into English and math courses. In addition, the UNLV academic advising community will communicate with students about the benefits of utilizing ALEKS for placement.

**UNIVERSITY OF NEVADA, LAS VEGAS**

**RESOURCES SUPPORTING IMPLEMENTATION OF TITLE 4, CHAPTER 16, SECTION 1**

**DIRECTIONS:** Indicate the existing and new resources that will be dedicated to your action plan for implementing the provisions of Title 4, Chapter 16, Section 1. You may edit the template as you see fit to appropriately represent institutional resources dedicated to implementation.

**PERSONNEL**

|                           | Existing  |           |           |           | New*      |           |           |           |
|---------------------------|-----------|-----------|-----------|-----------|-----------|-----------|-----------|-----------|
|                           | Headcount |           | FTE       |           | Headcount |           | FTE       |           |
|                           | Full-time | Part-time | Full-time | Part-Time | Full-time | Part-time | Full-time | Part-Time |
| Faculty - mathematics**   | 6         | 40        | 6.0       | 18.0      |           |           |           |           |
| Faculty - English**       | 2         | 60        | 2.00      | 50.0      | 1         |           | 1.0       |           |
| Advisors                  | 59        |           | 59.00     |           | 4         |           | 4.0       |           |
| Writing Center Consultant |           |           |           |           | 1         |           | 1.0       |           |

\*New hires or reallocation of existing positions to support implementation of T4, Ch 16, Section 1 and institutional action plan

\*\*Faculty who teach gateway courses, FTE figure should be for the portion of their time dedicated to gateway course instruction

**OTHER COSTS OR RESOURCES**

Software or Programming Support - Please indicate other costs such as software or programming support to provide intrusive advising, and other automation of the enrollment requirements or continuous enrollment

|   | 2016-17 | 2017-18 | 2018-19 |
|---|---------|---------|---------|
| EAB Student Success Collaborative - student tracking capabilities | 100,000 | 100,000 | 100,000 |
| Other Costs (please indicate)                                     |         |         |         |
| Other Costs (please indicate)                                     |         |         |         |
| Other Costs (please indicate)                                     |         |         |         |

|                                   | 2016-17 | 2017-18# | 2018-19 |
|-----------------------------------|---------|----------|---------|
| Math Learning Center              | 645,000 | 657,400  | 657,400 |
| English Gateway                   | 270,000 | 255,000  | 255,000 |
| Other Resources (please indicate) |         |          |         |
| Other Resources (please indicate) |         |          |         |

# - 2% COLA increase on salary

August 2015 - The English Department sponsored a 4-day Mentor Training Institute as part of a larger plan to eliminate remedial courses and shift from placement cut scores. The goal of the institute was to increase student success by providing instructors teaching gateway courses a range of instructional tools that would help them meet the needs of students at all levels.



**UNR**

**Institutional Gateway Course Action Plan**

The revisions to the Board's policy (*Title 4, Chapter 16, Section 1*) adopted in June 2015, as recommended by the Task Force on Gateway Mathematics, were based in large-part on the protocols already in place at UNR. Therefore, UNR has effectively already implemented the revised provisions of *Title 4, Chapter 16, Section 1* and as a result was not required to develop an action plan for the purpose of implementation.

**NSC**

**Institutional Gateway Course Action Plan**

**NEVADA STATE COLLEGE**  
**Gateway Course Success**  
*Action Plan for the Implementation of [Title IV, Ch. 16, Section 1](#)*

For the sake of clarity in addressing this charge, we unpacked the overall Board of Regents policy into its primary component parts (e.g., placement criteria, exemption from remediation, etc.) for the Policy and Enforcement elements of the report.

| 1. POLICY FRAMEWORK  |  |                        |
|--|--|------------------------|
| Current Status & Identified Gaps   | Action Steps   | Timeline <sup>1</sup>  |
| <p><b>A) Placement Criteria</b></p> <p><u>Current Status</u></p> <ul style="list-style-type: none"> <li>Consistent with Title 4, Ch. 16, Section 1 of the BoR Handbook, NSC makes ability-to-benefit determinations using approved tests, as delineated in our <a href="#">College Catalog</a>.</li> </ul> <p><u>Gaps</u></p> <ul style="list-style-type: none"> <li>None.</li> </ul>  | <p>None.</p> <ul style="list-style-type: none"> <li>The institution is in compliance with this requirement.</li> </ul> | <p>Not applicable.</p> |
| <p><b>B) Appropriate Placement (Exemption from Remediation)</b></p> <p><u>Current Status</u></p> <ul style="list-style-type: none"> <li>As defined in our <a href="#">College Catalog</a>, existing NSC policy exempts students from mathematics remediation if they eclipse designated minimum scores on the following approved placement tests:<br/>           ACT &gt; 21<br/>           SAT &gt; 490<br/>           Accuplacer (EA) &gt; 84</li> <li>English remediation is not offered at NSC; however, students can be referred to remediation at a 2-year college in the state system if they do not surpass one of the minimum scores on the approved placement tests. As per the <a href="#">NSC catalog</a>, the following scores are required to be exempt from English remediation:</li> </ul> | <p>None.</p> <ul style="list-style-type: none"> <li>The institution is in compliance with this requirement.</li> </ul> | <p>Not applicable.</p> |

<sup>1</sup> Unless noted otherwise, overarching guidance (and nagging) regarding the implementation of project goals will be provided by the Vice Provost for Academic Innovation & Student Success.

|   |   |  |
|---|---|--|
| <p>ACT &gt; 17<br/>SAT &gt; 430<br/>Accuplacer (RC &amp; SS) &gt; 59</p> <p><u>Gaps</u></p> <ul style="list-style-type: none"> <li>• None.</li> </ul>   |   |  |
| <p><b>C) Gateway Course Completion in 1 Year</b></p> <p><u>Current Status</u></p> <ul style="list-style-type: none"> <li>• For students who place into remediation, our current system ensures that they have an opportunity to enroll in and complete gateway college math and English courses within one academic year (note: English remediation is not offered at NSC, but a student who is referred to remediation elsewhere can return to NSC and complete college English in a single year).</li> <li>• For the mathematics curriculum, students who earn the appropriate placement score can enroll in either our conventional version or our stretch version of college math in their first semester. Students who fall below this cutoff (ACT &lt; 20, SAT &lt; 460, or Accuplacer (EA) &lt; 85) place into MATH 95M; successful completion of this course leads to MATH 120E in the subsequent semester, which can be completed to fulfill the core curriculum math requirement in less than a year.</li> </ul> <p><u>Gaps</u></p> <ul style="list-style-type: none"> <li>• Technically, there are none. However, for the English curriculum, if students are referred to a 2-year college for remediation, their entire trajectory could require more than a year of work. However, once at NSC they would be able to complete the English core curriculum requirements in a year or less.</li> </ul> | <p>None.</p> <ul style="list-style-type: none"> <li>• The institution revised its remedial math curriculum and policies in spring 2015 to establish consistency with the Board of Regents policy. The resulting curriculum nullified our three remediation modules and replaced them with a curriculum that begins with a 1-semester remedial course (MATH 95M) and is followed by a culminating “stretch” version of college math (MATH 120E)</li> </ul> | <p>Not applicable.</p>   |
| <p><b>D) Continuous Enrollment</b></p> <p><u>Current Status</u></p> <ul style="list-style-type: none"> <li>• Pursuant to <a href="#">Title 4, Ch. 16, Section 1</a> of the Board of</li> </ul>  | <p>Adopt a continuous enrollment policy that is consistent with <a href="#">Title 4, Ch. 16, Section 1</a> of the BoR Handbook.</p> <ul style="list-style-type: none"> <li>• The NSC policy will mirror the language of the BoR policy, affirming that all degree-seeking students must be continuously</li> </ul>  | <p><i>April 2016</i> – Discuss policy implementation with the Provost and the Registrar.</p> |

|   |   |  |
|---|---|--|
| <p>Regents Handbook, “all degree-seeking students must be continuously enrolled in appropriate mathematics and English courses until the institutional core curriculum mathematics and English requirements are completed.” This policy is not currently enforced at NSC.</p> <p><u>Gaps</u></p> <ul style="list-style-type: none"> <li>At present, we do not have a formal policy at NSC that explicitly enforces this statute. We indirectly support this policy through a provision that places a hold on the accounts of students who do not complete their core curriculum math and English requirements in 30 credits or less, but this provision is inadequate. Consequently, we plan to implement a formal policy for the spring 2016-17 year.</li> </ul> | <p>enrolled in appropriate math and English courses until the core curriculum requirements are met (unless an exception is made).</p> | <p><i>May 2016</i> – Present the change in policy to the Faculty Senate and relevant stakeholders (e.g., the Advising Center). Effort will be led by the VPAISS and the Director of Student Support Services.</p> <p><i>May-June 2016</i> – Adopt the policy into the 2016-2017 NSC Academic Catalog and updated relevant materials (e.g., the NSC website) accordingly. Effort will be led by the VPAISS and the Registrar.</p> |
| <p><b>E) Publicize Requirements to Nevada School Districts</b></p> <p><u>Current Status</u></p> <ul style="list-style-type: none"> <li>Currently, this stipulation is not supported by a formal policy; however, relevant college constituents (e.g., recruiters, admissions and records staff) communicate the expectations associated with the policy to the school districts upon request.</li> </ul> <p><u>Gaps</u></p> <ul style="list-style-type: none"> <li>Current policies, while informally conveyed to the district as needed, are not formally communicated via recruitment efforts and college publications (e.g., catalog, website).</li> </ul>   | <p>Ensure that the updated policy is properly communicated to the appropriate Nevada school districts.</p>                            | <p><i>April 2016</i> – Apprise NSC recruiters and personnel in the Office of Admissions &amp; Records of the policy regarding college math and English protocols and requirements and ensure that it is communicated via recruiting efforts.</p> <p><i>May 2016</i> – Update the policy in the NSC Academic Catalog and on the institutional website.</p>  |

| 2. ENFORCEMENT MEASURES  |  |                        |
|--|--|------------------------|
| Current Status & Identified Gaps   | Action Steps   | Timeline               |
| <p><b>A) Placement criteria</b></p> <p><u>Current Status</u></p> <ul style="list-style-type: none"> <li>New, first-time NSC students cannot enroll in courses</li> </ul> | <p>None.</p> <ul style="list-style-type: none"> <li>The institution is in compliance with this requirement.</li> </ul> | <p>Not applicable.</p> |

|  |  |  |
|--|--|--|
| <p>without submitting an appropriate placement score. The enforcement mechanism is twofold:</p> <ol style="list-style-type: none"> <li>1) First-time students are unable to register for student orientation without submitting placement scores AND</li> <li>2) They cannot register for courses without participating in orientation, as described in our <a href="#">College Catalog</a>.</li> </ol> <ul style="list-style-type: none"> <li>• A hold on their account (a new student orientation hold coded as “RORIE”) ensures that students cannot register for courses until submitting their placement scores and participating in orientation.</li> <li>• Once the scores are submitted, Admissions &amp; Records enters them into the system. Within a day, the scores are viewable to other stakeholders, most notably the Student Orientation Coordinator, who plays a pivotal role in the placement of students into their inaugural math and English courses through summer orientation.</li> </ul> <p><u>Gaps</u></p> <ul style="list-style-type: none"> <li>• None</li> </ul> |  |  |
| <p><b>B) Appropriate Placement (Exemption from Remediation)</b></p> <p><u>Current System</u></p> <ul style="list-style-type: none"> <li>• At present, appropriate placement is enforced through a combination of a) administratively-guided enrollment and b) registration holds that are designed to keep students enrolled in the correct math and English courses.</li> <li>• With our current system, placement test scores are provided to the Student Orientation Coordinator, who then registers students for the proper math &amp; English courses during summer orientation sessions. This administrative guidance helps ensure that students wind up in the recommended curriculum.</li> <li>• Furthermore, an orientation hold on the students’ accounts prevents them from changing the math or English course without seeing an advisor.</li> </ul>   | <p>This component of the action plan is designed largely to address the challenges illustrated in the column to the left.</p> <p><i>Goal – Increase Course Availability</i></p> <ul style="list-style-type: none"> <li>• Generally, administratively enrolling students into recommended blocks of fall core curriculum courses has worked well for our institution. However, because course scheduling is somewhat decentralized across the three departments involved with the core curriculum (the Social Sciences, Physical &amp; Life Sciences, and Humanities), time conflicts among key courses (e.g., English and math) have inhibited our ability to create a diverse selection of “blocks” that fit a wide array of student schedules. Consequently, we plan to create blocks that are more amenable to a broader proportion of students by minimizing the likelihood that key required courses conflict with each other. The Associate Dean of Liberal Arts &amp; Sciences will be collaborating with the Director of Student Support Services in spring 2016 to</li> </ul> | <p><i>January 2016</i> – Build additional college math courses into the fall 2016 schedule. This is an ongoing effort, but so far we have substantially increased the number of college math course offerings for students.</p> <p><i>February-April 2016</i> – Develop improved schedule with more course offerings and fewer class conflicts. Initiative is being led by the Associate Dean of Liberal Arts &amp; Sciences and the Director of Student Services (in collaboration with department chairs).</p> |

|   |  |   |
|---|--|---|
| <p><u>Gaps</u></p> <ul style="list-style-type: none"> <li>• According to fall 2015 data, the existing enforcement measures yield very high proportions of students who place into the appropriate math and English courses. An encouraging <b>97 percent</b> of first-time students with no prior college experience who participated in student orientation were registered for a math course in fall 2015; among similar students who missed orientation, this number fell to 78 percent.</li> <li>• Consequently, with this initiative we focus less on changes to the existing enforcement measures and more on how we can increase the effectiveness of those measures. The challenges we face are delineated below, and goals designed to address them are described in our action plan to the right.</li> </ul> <p><i>Challenge – Course Availability</i></p> <ul style="list-style-type: none"> <li>• Course availability is a significant detriment to the full enforcement of this policy. The most noteworthy challenges are that all math and English courses reach their max enrollment, or that available in-person courses are offered at a time that does not fit students' schedules.</li> </ul> <p><i>Challenge – Orientation Participation</i></p> <ul style="list-style-type: none"> <li>• A noteworthy number of students come to NSC too late to reliably participate in an orientation session.</li> </ul> <p><i>Challenge – Manual Student Registration</i></p> <ul style="list-style-type: none"> <li>• We face two challenges in regards to manual student orientation:       <ol style="list-style-type: none"> <li>1) Though we administratively enroll new students in the appropriate sections of math and English (based on their placement), and place a hold on their accounts that prevents them from dropping the course on their own, students do have the ability to drop the course if they consult an advisor.</li> <li>2) The registration hold prevents students from</li> </ol> </li> </ul> | <p>refine the schedule for a fall 2016 launch.</p> <ul style="list-style-type: none"> <li>• This effort also has been aided by the inception of MATH 120E. With the addition of this course option, the number of potential college math courses from which students can choose is increasing substantially, which should help students find a course that fits their schedules. For example, from fall 2014 to fall 2015 the number of in-person sections of college math doubled, and from spring 2015 to spring 2016 the number of sections tripled, from two to six.</li> <li>• Ideally, we would like to also offer more sections of math and English courses at times that are most amenable to student availability (e.g., if we know that 3:30 works for a larger proportion of students than 8 am, we can adjust accordingly), but collecting this information on a broad scale is a logistical challenge we have yet to address, much less solve. The addition of a program like <i>College Scheduler</i> could be advantageous in this regard.</li> </ul> <p><i>Goal – Increase Orientation Participation</i></p> <ul style="list-style-type: none"> <li>• We try to register as many students as possible for face-to-face orientation sessions in the summer preceding their first term, but invariably students are unable to attend a session (often because they are admitted late in the season). In response, we plan to provide an online orientation for students who are unable to participate in a face-to-face orientation.</li> <li>• Work on a self-paced online orientation workshop began in fall 2015 and will be completed before the end of the spring 2016 semester. For students who miss the face-to-face orientation, the registration hold on their accounts will not be lifted until they:       <ol style="list-style-type: none"> <li>a) Complete the online orientation</li> <li>b) Meet with an advisor to lift the hold and register for the appropriate courses</li> </ol> </li> </ul> <p><i>Goal – Alleviate Manual Registration Problems</i></p> <ul style="list-style-type: none"> <li>• Improve staff training to ensure that advisors know how to guide students who wish to drop their math and/or English courses. The training should involve a clear rationale that helps students understand why they were enrolled in these courses, and illustrates the consequences of making a change. Naturally,</li> </ul> | <p><i>April 2016</i> – Provide advisor staff training regarding the requirements of Title 4, Ch. 16, Section 1 and related concerns (e.g., how to guide students who wish to drop required math and English courses).</p> <p><i>April-May 2016</i> – Explore the possibility of establishing an admissions deadline for fall admits with the Provost, President, and key staff in the Office of Admissions &amp; Records.</p> <p><i>April 2016</i> – Complete development of new online orientation workshop. Work will be completed by the Student Orientation Coordinator in conjunction with staff from Instructional Technology and the Director of Student Support Services.</p> <p><i>Summer 2016 (launching May 1, 2016)</i> – Administer online orientation workshop (led by the Student Orientation Coordinator with support from Instructional Technology and the advising team).</p> <p><i>Summer 2016</i> – For students who have been registered for fall 2016 courses, replace their registration hold with a drop consent restriction that solely prevents them from changing their math and English courses</p> |
|---|--|---|



|  |   |   |
|--|---|---|
| <p>altering their math and English courses, but it also prevents them from adjusting other courses as needed. This creates a strain on our students, who cannot adjust courses that are free from special Board policies without permission (e.g., PSY 101), and on our advisors, who must intervene in an often-time consuming fashion to help students adjust their schedules.</p>   | <p>improved course availability also will lessen the number of students who wish to manually adjust their courses.</p> <ul style="list-style-type: none"> <li>• Replace our current registration hold with establish a drop consent system that allows students to change courses other than math and English.</li> </ul> <p><i>Tentative Goal – Establish an Admissions Deadline for Fall Admits</i></p> <ul style="list-style-type: none"> <li>• Establish an earlier admissions deadline that allows more students to participate in our face-to-face summer student orientation. At present, students can be admitted virtually up to the start of the fall semester.</li> <li>• Note: this goal is tentative because it requires a consultation with the college president that has not yet occurred.</li> </ul>   | <p>without advisor approval.</p>  |
| <p><b>C) Gateway Course Completion in 1 Year</b></p> <p><u>Current System</u></p> <ul style="list-style-type: none"> <li>• As noted in the section on the Policy Framework, we currently provide a curriculum that allows students to complete their math and English core curriculum requirements in a year or less.</li> <li>• <i>Math:</i> Students who earn the appropriate placement score can place into either our conventional version or our stretch version of college math in their first semester. Students who fall below this cutoff (ACT &lt; 20, SAT &lt; 460, or Accuplacer &lt; 85) place into MATH 95M; successful completion of this course leads to MATH 120E in the subsequent semester, which can be completed to fulfill the core curriculum math requirement in less than a year</li> <li>• <i>English:</i> NSC does not currently offer remediation. Students are either placed into ENG 100 or ENG 101, which are both college-level composition courses. Successful completion of either course leads to ENG 102, which is the culmination of their core curriculum requirements. The full sequence can be completed in two semesters.</li> </ul> <p><u>Gaps</u></p> <ul style="list-style-type: none"> <li>• Though students can finish their core English requirements in a single year or less at NSC, those who</li> </ul> | <p>As it stands, the current system meets this requirement. However, in the coming year we hope to address two related issues:</p> <p><i>Goal – Examine English Remediation Pathway</i></p> <ul style="list-style-type: none"> <li>• Though the English core curriculum can be completed in a year or less for students who take all of their coursework at NSC, students who place into remediation likely will need more than a year to meet the requirements. We hope to address this through consultation with 2-year colleges in NSHE and a re-examination of our placement methods (which may result in fewer students being referred to remediation).</li> </ul> <p><i>Goal – Revamp Math Placement Methods</i></p> <ul style="list-style-type: none"> <li>• At present, an extremely high proportion of NSC students are placed into remediation (roughly 80%), largely through an Accuplacer assessment. Given that the literature increasingly recommends “stretch” college courses over conventional math remediation, we plan to increase the placement of students into stretch courses using the EdReady platform. Students will be given an opportunity to hone their math skills using the platform, and those who reach the minimum approved score will be placed into MATH 120 or MATH 120E.</li> </ul> | <p><i>March-May 2016</i> – Examine English remediation policy. Effort will be led by the Department Chair of the Humanities in conjunction with a composition lecturer who specializes in placement methods.</p> <p><i>May-July 2016</i> – Pilot EdReady platform as a means of placing new admits into their fall semester math courses. Initiative will be guided by an Assistant Professor of Mathematics, our Remedial Math Coordinator, and our Instructional Technology Manager. Students in our TRIO-SSS program may be the initial target population for this effort.</p> |

|   |  |   |
|---|--|---|
| <p>are referred to remediation at another institution may need more than a year to satisfy the core.</p>  |  |   |
| <p><b>D) Continuous Enrollment</b></p> <p><u>Current System</u></p> <ul style="list-style-type: none"> <li>• Our existing system does not properly enforce continuous enrollment</li> </ul> <p><u>Gaps</u></p> <ul style="list-style-type: none"> <li>• There appear to be two obvious stop-out possibilities: <ul style="list-style-type: none"> <li>1) <i>Registration Persistence</i> – Students complete the first semester of college math/English, but do not enroll in the second half of the sequence (as needed)</li> <li>2) <i>Course Persistence</i> – Students enroll in the correct class but drop out before completing the course.</li> </ul> </li> </ul> <p><i>Challenge – Registration Persistence</i></p> <ul style="list-style-type: none"> <li>• Students complete the first half of the college math or English sequence (e.g., MATH 95M, ENG 100), but do not enroll in the subsequent course in the spring.</li> </ul> <p><i>Challenge – Course Persistence</i></p> <ul style="list-style-type: none"> <li>• Students register for the correct course in the spring term, but do not remain enrolled in the course.</li> </ul> | <p>We are considering, but have not unequivocally committed to, two different means of addressing the challenge of registration persistence.</p> <p><i>Goal – Use Holds to Increase Registration Persistence</i></p> <ul style="list-style-type: none"> <li>• Place a registration hold on the accounts of new, first-time students that prevents them from enrolling in spring courses without meeting an advisor; the advisor can ensure that the student enrolls in the correct math and English courses.</li> </ul> <p><i>Goal – Use Administrative Enrollment to Increase Registration Persistence</i></p> <ul style="list-style-type: none"> <li>• Administratively enroll students into the appropriate math/English course and use a drop consent system to prevent students from changing the course. We may need to do this administratively (though from a student perspective it would be automatic), but Admissions &amp; Records can do it as a batch process if they have the names of the students who need to be enrolled in the spring. Our math coordinator can provide Admissions &amp; Records with a list of students based on their performance in the fall math remediation course.</li> <li>• To facilitate this, in student orientation we will apprise students of the full, yearlong expectations regarding math and English. They will be informed of the automatic enrollment into the correct math and English courses in the spring semester, and will be provided with a tentative schedule. Specifically, we would administratively enroll students in their fall courses as we did for fall 2015, and present the students with a limited range of options for the spring math and English courses (e.g., MATH 120E in the morning, afternoon, or evening) from which they can make a selection. Our Remedial Math Coordinator would track the performance of the students in the fall semester and work with staff in Admissions and Records to batch enroll students in the correct course in the subsequent semester (e.g., all students who pass MATH 95 will be administratively registered for their chosen section of MATH 120E in the spring).</li> </ul> | <p><i>February-May 2016</i> – Discuss the two goals to increase registration persistence with key stakeholders – Chair of Physical &amp; Life Sciences, Director of Student Support Services, Director of Admissions, Advising Staff, Financial Aid Director, and the Remedial Math Coordinator.</p> <p><i>April 2016</i> – Reach decision about which persistence goal to implement.</p> <p><i>May-September 2016</i> – Work with Director of Institutional Research and Student Orientation Coordinator to develop a superior method of tracking students enrolled in fall and spring math and English courses.</p> <p><i>Summer 2016</i> – Pilot the implementation of the chosen persistence goal in the summer 2016 orientation.</p> <p><i>Summer 2017</i> – Achieve full implementation of the chosen persistence goal.</p> |

|  |   |  |
|--|---|--|
|  | <p><i>Goal – Increase Course Persistence</i></p> <ul style="list-style-type: none"> <li>• Apply a drop consent restriction that prevents students from changing their spring semester math and English courses without seeing an advisor.</li> </ul> <p><i>Goal – Improve Understanding of Student Attrition</i></p> <ul style="list-style-type: none"> <li>• Improve tracking of students enrolled in spring (and fall) math and English courses to determine how and why students fail to register and remain in these courses. Potential causes include: <ul style="list-style-type: none"> <li>○ Students visited an advisor to make a course change</li> <li>○ Students failed to participate in orientation</li> <li>○ Students participated in orientation but were incorrectly placed</li> <li>○ Students enrolled in the proper courses in the fall, but were not administratively enrolled in the correct spring courses</li> </ul> </li> </ul> |  |
|--|---|--|

For advising and outreach, we eschewed the fine level of detail (i.e., component parts) needed to address the Policy Framework and Enforcement Measures elements of this report. Rather, we chose to focus more broadly on Board Policy, Enforcement Measures, and Messaging because the efforts of the advisors will not differentiate greatly according to the different elements of the continuing enrollment policy.

| <b>3. ADVISING &amp; OUTREACH</b>  |   |  |
|--|---|--|
| <b>Current Status &amp; Identified Gaps</b>  | <b>Action Steps</b>   | <b>Timeline<sup>2</sup></b>  |
| <p><b>A) Board Policy</b></p> <p><u>Current Status</u></p> <ul style="list-style-type: none"> <li>• Advisors apprise students of three components of Title 4, Ch. 16, Section 1: the methods of placement (placement criteria), the consequences of different placement scores (appropriate placement), and the pathways to completing the math and English core curriculum requirements in a single year at NSC.</li> </ul> <p><u>Gaps</u></p> <ul style="list-style-type: none"> <li>• At present, though advisors may discuss the benefits of completing math and English in a single year, and thus</li> </ul> | <p>A special training session will ensure that all advisors are intimately familiar with the stipulations of Title 4, Ch. 16, Section 1 of the BoR Handbook.</p> <p>The training session will be developed by the Director of Student Support Services and will address topics including but not limited to:</p> <ul style="list-style-type: none"> <li>• Our placement policy and relevant placement test scores.</li> <li>• The appropriate placement provision (including the stipulation for exemption from remediation)</li> <li>• The requirement to permit the completion of core curriculum math and English in a single year, including a detailed understanding of our pathways at NSC (e.g., the MATH 95M → MATH 120E sequence).</li> <li>• The continuous enrollment provision that requires students to</li> </ul> | <p><i>April 2016</i> – Director of Student Support Services develops training session for advisors.</p> <p><i>May 2016</i> – Training sessions are conducted with the advising team prior to the onset of fall 2016 registration.</p> <p><i>October 2016</i> – Training sessions are reiterated, as needed, prior to the opening of spring</p> |

<sup>2</sup> Unless noted otherwise, overarching guidance (and nagging) regarding the implementation of project goals will be provided by the Vice Provost for Academic Innovation & Student Success.

|   |   |  |
|---|---|--|
| <p>may encourage students to take the appropriate courses in a fall-spring sequence, they are not necessarily apprising students of the continuous enrollment policy. It is not, at present, a policy that we have adopted.</p>   | <p>remain enrolled in the appropriate math and English courses until the core curriculum requirements have been met.</p> <ul style="list-style-type: none"> <li>• The mechanism by which registration holds and drop consent restrictions can be added and removed via PeopleSoft.</li> <li>• Importantly, the advisors also will be provided with information about the rationale for the policy, including available data about the success rates of students who complete their math and English gateway course requirements in a single year.</li> </ul>  | <p>registration.</p>   |
| <p><b>B) Enforcement Measures</b></p> <p><u>Current Status</u></p> <ul style="list-style-type: none"> <li>• Advisors assist with the enforcement of policy in a number of ways: <ul style="list-style-type: none"> <li>○ All advisors participate in summer orientation sessions and help register students for their fall blocks of courses</li> <li>○ Advisors meet individually with students to discuss their registration holds and remove those holds if a student needs to change a course</li> <li>○ Members of the advising team are working with the Associate Dean of LAS to develop a fall course schedule that is more amenable to student availability (which in turn will facilitate our ability to place and maintain students in the right courses)</li> <li>○ Advisors meet individually with students to help them resolve challenges in math and English courses, which improves success rates in these courses.</li> </ul> </li> </ul> <p><u>Gaps</u></p> <ul style="list-style-type: none"> <li>• At present, advisors are not involved in the continuous enrollment provision. Depending on which solution we pursue (administrative enrollment in the spring vs. advisor enrollment), advisors may play a critical role in this process.</li> </ul> | <p>Though much of the enforcement of the Board policy will be achieved through student orientation, the NSC advising team will play an integral role in the full implementation of the policy. The advisors will help us:</p> <ul style="list-style-type: none"> <li>• Apprise students, as needed, of the ability-to-benefit placement system and the different placement test options.</li> <li>• Apprise students of college math and English stipulations regarding continuous enrollment and the desired completion of this curriculum in a year or less.</li> <li>• Apprise students of their fall semester blocks and spring math and English courses at orientation.</li> <li>• Register students for courses in their fall semester blocks at orientation (including helping students make adjustments so that the block fits their schedules).</li> <li>• Meet individually with students who have taken the online orientation to place them into courses.</li> <li>• Meet individually with students to answer questions about their fall semester blocks after summer orientation or adjust their schedules, as needed (through the removal of drop consent restrictions).</li> <li>• Hold registration labs once per week during the summer to assist in making scheduling changes (or help them understand the rationale for keeping their existing schedule, as needed).</li> <li>• If we choose the method of continuous enrollment that relies on a registration hold, advisors will meet with students in the fall semester to remove the hold and register them for their spring math and English courses.</li> </ul> | <p><i>Summer 2016</i> – Advisors participate in summer orientation and help guide students into their fall blocks of courses.</p> <p><i>August 2016</i> – Advisors meet with students who only participated in the online orientation to place them in recommended blocks of courses.</p> <p><i>Fall 2016</i> – Advisors meet with students to help them adjust their courses and, where possible, encourage students to retain their fall semester math and English courses.</p> <p><i>Fall 2016 (tentative)</i> – Advisors meet with students to lift registration holds and enroll them in their spring math and English courses.</p> |

|   |   |  |
|---|---|--|
| <p><b>C) Messaging</b></p> <p><u>Current Status</u></p> <ul style="list-style-type: none"> <li>• For students who place into remediation, our current system ensures that they have an opportunity to enroll in and complete gateway college math and English courses within one academic year (note: English remediation is not offered at NSC, but a student who is referred to remediation elsewhere can return to NSC and complete college English in a single year).</li> <li>• For the mathematics curriculum, students who earn the appropriate placement score can enroll in either our conventional version or our stretch version of college math in their first semester. Students who fall below this cutoff (ACT &lt; 20, SAT &lt; 460, or Accuplacer (EA) &lt; 85) place into MATH 95M; successful completion of this course leads to MATH 120E in the subsequent semester, which can be completed to fulfill the core curriculum math requirement in less than a year.</li> </ul> <p><u>Gaps</u></p> <ul style="list-style-type: none"> <li>• Technically, there are none. However, for the English curriculum, if students are referred to a 2-year college for remediation, their entire trajectory could require more than a year of work. However, once at NSC they would be able to complete the English core curriculum requirements in a year or less.</li> </ul> | <p>It is essential that advisors possess a clear understanding of a) why students should be encouraged to complete their math and English core curriculum requirements in a year or less and b) the most common reasons why students fail to meet these requirements. For the former, the advisors not only need to understand the Board policy, but also the underlying reason for the existence of the policy (e.g., the elevated success rates associated with the timely completion of math and English core curriculum requirements).</p> <p>We plan to conduct multiple assessments to gauge why existing enforcement measures fail. These assessments include direct conversations with students about the challenges they face in trying to meet the requirement – culminating in a group discussion among the advisors to codify the reasons – and an examination of data from the Office of Institutional Research. These latter data will include the percentage of students who register for the appropriate fall and spring math and English courses as a function of:</p> <ul style="list-style-type: none"> <li>• Summer student orientation participation</li> <li>• Online orientation participation</li> <li>• Date of orientation participation</li> <li>• Date of admission to the college</li> <li>• Date of placement score submission</li> <li>• Meetings with an advisor to change their schedules</li> </ul> <p>Equipped with information about why students <i>should</i> meet the stated requirements and why they often fail to do so, advisors can more effectively navigate discussions with students that are designed to persuade them to adhere to policy.</p> | <p><i>April 2016</i> – Director of Student Support Services develops training session for advisors.</p> <p><i>May 2016</i> – Training sessions are conducted with the advising team prior to fall 2016 registration opens</p> <p><i>April-June 2016</i> – Advising team meets to discuss and codify reasons why students fail to adhere to the pathway recommended by Board policy and enforced by NSC protocol.</p> <p><i>October 2016</i> – Training sessions are reiterated, as needed, prior to the opening of spring registration</p> |
|---|---|--|

Note: The guidelines presented by the Chancellor’s office focused less on the gaps between our current communication efforts and what is needed to align with policy, and more on the message, the targets, the means of communications, and the timeline. This is reflected in the table below.

| 4. COMMUNICATION STRATEGIES |  |  |  |
|-----------------------------|--|--|--|
|                             | Message  | Communication Channels   | Timeline   |
| <b>Policy</b>               | In regards to policy, both internal and external audiences must be apprised of the requirements of Board policy through multiple communication channels. | <p><u>Hobsons CRM</u><br/> <i>Target:</i> Recently admitted NSC students.</p> <ul style="list-style-type: none"> <li>The Hobsons CRM is an indispensable component of our communication strategy. Through this platform we can send automated messages to students who have been admitted to the college informing them of key requirements, including:               <ul style="list-style-type: none"> <li>The need to submit placement scores prior to signing up for orientation and the means of doing so.</li> <li>The need to sign up for and participate in summer orientation as part of the fall course enrollment process (with registration happening at orientation)</li> </ul> </li> <li>Hobsons provides “clickthrough” data that show whether students have read a message, and the platform allows us to orchestrate automatic messages for students who have not read or responded to the initial communication.</li> <li>Once read, the Hobsons messages will direct students to complete an online pre-orientation module.</li> <li>After students have completed the online module, they will receive another message with a link to RSVP for the summer student orientation.</li> </ul> <p><u>Mobile Device Correspondence</u><br/> <i>Targets:</i> Recently admitted NSC students.</p> <ul style="list-style-type: none"> <li>To further increase the student response rate to our communications regarding placement tests and summer orientation, peer mentors and math department student workers will call and text message prospective students who have not yet submitted a score or RSVP’d for orientation. They will communicate the need to complete this process and the rationale for doing so.</li> </ul> <p><u>NSC College Catalog</u><br/> <i>Targets:</i> All potential audiences, including prospective students, current students, area school districts, and college constituents (e.g., advisors).</p> | <p><i>March-April 2016</i> – Present College Catalog revisions to the Provost and Registrar.</p> <p><i>May 2016</i> – Present catalog revisions to faculty senate.</p> <p><i>March-July 2016</i> – Send communications to admitted NSC students via the Hobsons CRM.</p> <p><i>May-June 2016</i> – Incorporate catalog revisions into the production of the 2016-17 College Catalog.</p> <p><i>April 2016-August 2016</i> – Create short video that describes the policy and key enforcement measures (analogous product is this <a href="#">video</a> created for EdReady).</p> <p><i>May-August 2016</i> – Send mobile device correspondence to recently admitted students who have not submitted placement scores or RSVP’d for orientation.</p> <p><i>June-July 2016</i> – Eliminate</p> |

|  |  |   |   |
|--|--|---|---|
|  |  | <ul style="list-style-type: none"> <li>• Though we are currently applying the placement methods described in section 1.B of this document (under “Policy Framework”), the NSC catalog needs to be updated with this information.</li> <li>• Similarly, we have revised our math curriculum to permit the completion of gateway math in a single year, but this revision occurred in summer 2015 and is not yet presented in our College Catalog (though it is reflected in other materials used by math faculty and advisors).</li> <li>• We have not yet adopted a formal continuous enrollment policy that is consistent with Title 4, Ch. 16, Section 1 of the BoR Handbook, but once approved the policy must be added to the College Catalog.</li> <li>• In policy and practice we require students to submit a placement score prior to participating in summer orientation, but this is not explicitly stated in our catalog (rather, it is communicated to students via other pathways, such as by email and phone). The stipulation must be added to the 2016-17 College Catalog.</li> </ul> <p><u>Website</u><br/> <i>Targets:</i> All potential audiences, including prospective students, current students, area school districts, and college constituents (e.g., advisors).</p> <ul style="list-style-type: none"> <li>• Given the integration between the website and the College Catalog, updates to the catalog will automatically be reflected on our website.</li> <li>• However, we also need to remove our “Foundational Mathematics” page and create “College Math” and “College English” pages that illustrate the new system</li> <li>• Additionally, we plan to develop a short descriptive video, like <a href="#">this video</a> that we developed for the EdReady project, to apprise people of the changes. This video can be embedded on the website and referred to prospective students, the school district, and other stakeholders via recruiting visits, advising appointments, and orientation sessions.</li> </ul> <p><u>Recruitment</u><br/> <i>Target:</i> Prospective NSC students and high school counselors.</p> <ul style="list-style-type: none"> <li>• Our recruitment team must address the policy – and the</li> </ul> | <p>foundational math website and create college math and English websites that describe the policy and enforcement measures and include the aforementioned math video.</p> <p><i>June-August 2016 –</i><br/> Advisors and the Student Orientation Coordinator communicate information about the continuing enrollment policy during summer orientation; for students who miss orientation, this information will be communicated via the online orientation module (primarily in late July and August).</p> |
|--|--|---|---|

|             |  |   |                                   |
|-------------|--|---|-----------------------------------|
|             |  | <p>reasons for that policy – in their verbal and written communications to prospective NSC students.</p> <p><u>Advisors</u><br/> <i>Target:</i> Current NSC students.</p> <ul style="list-style-type: none"> <li>• Advisors will communicate critical information about the continuing enrollment policy via two primary mechanisms: 1) individual advising appointments and 2) summer student orientation sessions.</li> </ul> <p><u>Online Orientation Workshop</u><br/> <i>Target:</i> Incoming first-year students</p> <ul style="list-style-type: none"> <li>• A module in the workshop will communicate the continuous enrollment policy and the importance of completing specific courses within first year.</li> <li>• A separate module will apprise students of available resources (e.g., the Academic Success Center and Writing Center) that can facilitate their success in math and English.</li> </ul> <p><u>Summer Orientation (face-to-face)</u><br/> <i>Target:</i> Incoming first-year students</p> <ul style="list-style-type: none"> <li>• A session during summer orientation will reiterate the details of the continuous enrollment policy and will again stress the importance of completing specific courses within first year (namely, college math and English, key pre-requisites within the major, and certain core courses).</li> </ul> |                                   |
| Enforcement | In regards to our enforcement measures, all stakeholders must be apprised of both the nature of the measures and the <i>reason</i> for their existence. To this end, the messaging will delineate the different components of the policy as well as the supportive data that justify the provisions. | The communication channels will mirror the channels listed above. We will rely on the Catalog, our website, recruiters, phone and text messaging, Hobsons, and advisors to convey information to stakeholders about the enforcement of Board policy. It is simply a difference of communicating the enforcement message as opposed to the policy message (though both are obvious intertwined).   | See the timeline presented above. |



**NEVADA STATE COLLEGE**

**RESOURCES SUPPORTING IMPLEMENTATION OF TITLE 4, CHAPTER 16, SECTION 1**

**DIRECTIONS:** Indicate the existing and new resources that will be dedicated to your action plan for implementing the provisions of Title 4, Chapter 16, Section 1. You may edit the template as you see fit to appropriately represent institutional resources dedicated to implementation.

**PERSONNEL**

|                         | Existing (1) |           |           |           | New*                                  |                    |           |           |
|-------------------------|--------------|-----------|-----------|-----------|---------------------------------------|--------------------|-----------|-----------|
|                         | Headcount    |           | FTE       |           | Headcount                             |                    | FTE       |           |
|                         | Full-time    | Part-time | Full-time | Part-Time | Full-time                             | Part-time          | Full-time | Part-Time |
| Faculty - mathematics** | 3.0          | 7.0       | 1.7       | 2.8       | 3.0                                   | 8.0                | 2.0       | 2.8       |
| Faculty - English**     | 6.0          | 5.0       | 3.3       | 2.4       | 6.0                                   | 5.0                | 3.3       | 4.0       |
| Advisors                | 4.5          | 0.0       | N/A       | N/A       | 7.0                                   | 0.0                | N/A       | N/A       |
| Other (please indicate) | 0.0          |           |           |           | 2 (admissions & records personnel)    | 0.0                | N/A       | N/A       |
| Other (please indicate) | 0.5          |           |           |           | .5 (freshmen orientation coordinator) | 0.0                | N/A       | N/A       |
| Other (please indicate) | 0.0          |           |           |           |                                       | 1 (student worker) | N/A       | N/A       |

\*New hires or reallocation of existing positions to support implementation of T4, Ch 16, Section 1 and institutional action plan

\*\*Faculty who teach gateway courses, FTE figure should be for the portion of their time dedicated to gateway course instruction

**OTHER COSTS OR RESOURCES**

Software or Programming Support - Please indicate other costs such as software or programming support to provide intrusive advising, and other automation of the enrollment requirements or continuous enrollment

|                               | 2016-17   | 2017-18 | 2018-19 |
|-------------------------------|-----------|---------|---------|
| Other Costs (please indicate) | 25000 (2) | 20,000  | 20,000  |
| Other Costs (please indicate) |           |         |         |
| Other Costs (please indicate) |           |         |         |
| Other Costs (please indicate) |           |         |         |

|                                   | 2016-17 | 2017-18 | 2018-19 |
|-----------------------------------|---------|---------|---------|
| Other Resources (please indicate) |         |         |         |
| Other Resources (please indicate) |         |         |         |
| Other Resources (please indicate) |         |         |         |
| Other Resources (please indicate) |         |         |         |

1 - For "existing resources" we listed all of the available advisors and faculty at NSC in fall 2015. If we had focused on the existing advisors and faculty who are dedicated to the implementation of the Board policy the number would have been 0 in each category because the policy has not yet been implemented (we are in the planning phase now and initial stages of full implementation will begin in summer 2016). For "new resources" we listed all of the personnel who will contribute to the implementation in some capacity starting in summer 2016. We simply do not have sufficient resources to dedicate full-time personnel exclusively to the effort - nor can we hire new staff for expressly this purpose - but we are trying to ensure that all relevant instructors and advisors are dedicating part of their time to the implementation. Consequently, the number of faculty is not changing substantially from the "existing" to "new" categories in this document, but in reality we are shifting from not allocating instructors to the implementation to allocating as many of them as possible.

2 - This expense is associated with the cost of College Scheduler, which - by our last estimate - is \$25k for the first year and \$20k each subsequent year. We may not have the funds needed to pursue this platform, so this remains a speculative expense.

**CSN**

**Institutional Gateway Course Action Plan**

## Gateway Math and English Success Plan for

### College of Southern Nevada

February 5, 2016

During the fall 2015 semester, the Mathematics faculty at CSN were charged with making recommendations to the Vice President Academic Affairs about how to increase enrollments in Mathematics at CSN. Department chair, Patrick Villa, appointed a task force of full time faculty who met and made recommendations to the Vice President. The recommendations offered by this task force are:

1. Amend our Accuplacer cut-off score for entry into Math 95.
  - a. Our current policy dictates that students must score  $AR > 89$  and  $AG < 76$  (where AR stands for the Arithmetic Test and AG stands for the Elementary Algebra Test). We would like to add the following alternative to this permission: score of  $AR > 30$  and  $50 < AG < 76$ . RECOMMENDATION ACCEPTED
2. Change the software in Math Prep from MyMathLab to ALEKS Placement Test. Moreover, allow students exiting Math Prep to use their ALEKS Placement Test score to override their previously taken Accuplacer score, if it benefits them.
  - a. ALEKS Placement Test offers a diagnostic component missing from our current program and offers us a chance to try out a new nationally used placement exam. Moreover, ALEKS provides, what we believe, is a more effective remediation tool for developmental math concepts. RECOMMENDATION UNDER CONSIDERATION
3. Use grant money controlled by Student Services to increase students' placement scores by hiring and training tutors/teachers to supplement instruction in Math Prep classes. RECOMMENDATION ACCEPTED.
4. Change our current policy for Math Placement so that course grades expire after 2 years. After 2 years, students will need to retake the Placement Test before entry into a math class is permitted. RECOMMENDATION ACCEPTED
5. Rename Math Prep and advertise the new format of this program more diligently to counselors, advisers, and students. RECOMMENDATION ACCEPTED
6. Pilot additional Math 95 stretch classes in two formats; traditional 5 credit hour classes and 3 credit + 1 credit lab RECOMMENDATION ACCEPTED

### Policy Framework

1. Continuous Enrollment – Guided pathways for all degree and certificate programs at CSN show Math and English on the pathway during the first year of enrollment. Examples of these guided pathways are attached. Course catalog for 2016-2017 will include language about continuous enrollment in Math and English until student has completed the appropriate college-level math and English for the declared program of study. New, first time to CSN, recent high school graduates will have holds placed on their registration during the first and second semesters of enrollment through the mandatory matriculation process (MMP).

2. Placement criteria – Current CSN policy requires that students must score AR>89 and AG<76 where AR stands for the Arithmetic Test and AG stands for the Elementary Test. The math faculty recommended and administration approved the following alternative placement will be added: Scores of AR>30 and 50 <AG<76. This new cut off score falls more in line with the College Board recommendations. This placement criteria change will become effective July 1, 2016. These changes to placement scores in Math will be reflected in the 2016-2017 college catalog and will be communicated at the Testing Office. The English faculty did not alter placement scores; however, based on past assessment of student's reading abilities, the English faculty added a satisfactory placement score in Reading as a prerequisite to ENG 100/101. This prerequisite becomes effective with Fall 2016 enrollments. The Accuplacer Reading Placement test is mandatory for all new to CSN, recent high school graduates (the MMP cohort for fall 2016) and also mandatory for any student attempting to register for ENG 100 or 101 in fall 2016.
  
3. Procedures for placing and notifying students of registration holds – The MMP cohort for fall 2016 will be expanded to include all recent high school graduates. The message of mandatory holds is communicated to students during recruitment and upon receipt of the official acceptance letter into CSN. The registration holds require students to attend orientation (online or on ground), take placement test for English, Reading, and Math, and complete an academic advising appointment. During the mandatory academic advising session, the appropriate Math and English courses (depending on placement score and program of study) are populated into the student's myCSN shopping cart. The hold is then removed by academic advisors and students are free to register for fall semester. Shortly after the fall semester starts, those same students have another hold placed before second term enrollment. At the time of second term enrollment, the students are required to meet with an academic counselor who reviews placement score, fall enrollment, and again populates the student's myCSN shopping cart with the appropriate Math and English class. It is anticipated this will add approximately 200 additional students into the new to CSN cohort for fall 2016. This expanded cohort is approximately 30% of the overall new to CSN cohort. All students, new to CSN in fall 2016, will be expected to complete the on-line orientation, but mandatory placement testing holds will not become active until fall 2017.

### **Enforcement Measures**

1. Registration holds will be placed on all first time to CSN, recent high school graduates for fall 2016. Holds require mandatory orientation, mandatory placement testing for Math, English and Reading, and mandatory academic advising. The registration holds can only be removed by academic advisors. Registration holds will again be placed on second term enrollments of this recent high school graduate cohort. This second term registration hold can only be removed by academic counselors. During the mandatory academic advising session, the appropriate Math and English class, based on placement score, is placed into the student's myCSN shopping cart. The guided pathway for the student's declared program of study is also shared with the student. During the second term advising session, the academic counselor reviews the student's performance/enrollment in Math and English

during that first semester. The subsequent Math and English course is then placed again into the student's myCSN shopping cart and the second semester hold is removed. From that point on throughout the student's experience with CSN, there are no more holds placed on the account for purposes of enrollment.

This mandatory matriculation process, as of fall 2016, is expected to apply to approximately 2,500 new to CSN, recent high school graduates. This accounts for approximately 30% of the overall new to CSN admissions every fall semester.

2. Full implementation of mandatory matriculation is anticipated fall 2017 to affect approximately 8,000 students, new to CSN. The mandatory matriculation process will include holds on accounts until students have completed orientation, taken Math, English and Reading placement testing, and met with an academic advisor.
3. CSN adopted Hobson's CRM in early 2016. The Radius and Starfish modules are expected to be fully functioning by fall 2016. During fall 2016, in anticipation of fall 2017, the degree planner module will be built. Degree Planner will provide students real time feedback if they change a declared program of study, if they attempt to register for courses not on declared program of study, and will populate a guided pathway for them based on remediation placement.
4. Effective fall 2016, students will not be allowed to drop Math without instructor permission. This is another enforcement measure intended to keep students continuously enrolled in Math.

### **Advising and Student Outreach Plan**

1. Academic advising is mandatory prior to first term enrollment. During that academic advising session, students are provided with the guided pathway for the declared program of study. Students are shown where to find guided pathways for all degree and certificate programs at CSN. During this initial academic advising session, the appropriate Math and English (dependent on placement) is placed into the student's myCSN shopping cart. At the time of second term enrollment, the academic counselor reviews the student's experience that first semester, determines if the appropriate Math and English were taken and places the second semester recommendations for Math and English into the student's myCSN shopping cart.
2. Messaging about mandatory placement testing and continuous enrollment in Math is provided by the college recruiters. Orientation with the high school counselors includes emphasis on mandatory placement testing as well as need for students to be continuously enrolled in Math and English through completion of the gateway course. The initial communication to students once admitted to CSN includes information on required steps before enrollment.

3. In an effort to prepare students for the placement testing, students are provided access to YouTube videos to assist them with preparation for the placement testing. These videos can be found at

Episode 1: <https://www.youtube.com/watch?v=zKFm8Fy0kOQ>

Episode 2: <https://youtu.be/9Oh6dB8DKRk>

Episode 3: <https://youtu.be/xdsIRabx-GE>

Episode 4: <https://youtu.be/scHnGrgNW0g>

Episode 5: <https://youtu.be/PDpMLNm9E3I>

### **Communication Strategies**

1. Guided pathways are posted on the CSN web site concurrent with degree sheets.
2. Guided pathways will be printed in the 2016-2017 catalog adjacent to the degree sheet. The 2016-2017 catalog also contains language about need for continuous enrollment in Math and English until gateway course is completed.
3. Academic advisors will communicate with the non credit Math Prep program students to advise those students into the appropriate credit bearing Math course. Academic advising conducts Next Steps workshops with Math Prep and other non-credit students to better prepare students for conversion to credit bearing courses.
4. Academic advisors and faculty in developmental English advise students, once completed with ENG 098, to immediately enroll in college level English to insure continuous enrollment.
5. Continuous enrollment is included in the Orientation to CSN, both online and on ground.
6. All of the myCSN communications have been reviewed and edited to insure students are able to understand expectations at time of enrollment. Once admitted, during subsequent enrollment cycles, students continue to be prompted about declared program of study and completion of gateway math and English.
7. Adoption of the Degree Planner in the Hobson's CRM will commence in fall 2016. This module is expected to help students understand impact of changing a declared program of study as well as populate a guided pathway depending on remediation placement. The technology is also anticipated to be intrusive with students in understanding time to completion depending on credits taken in a semester.

## Additional Strategies

1. Allocation of three (3) NEW math faculty lines for hire fall 2016. One (1) NEW FTE English faculty line was authorized for hire fall 2016.
2. Pilot additional Math 95 stretch classes in two formats: traditional 5 credit hour classes and a 3 credit + 1 credit lab format as well
3. Continue to offer 5 credit stretches of MATH 120 and 124.
4. Continue to offer 8 week blocks of MATH 95/96, 95/120, 96/124.
5. Expand supplemental instruction. Through Perkins funding, CSN piloted supplemental instruction in specific Career and Technical Education Math courses (MATH 104 and 116) during fall 2015. While results were more positive in BIOL than in Math, we believe we need to better orient Math faculty on benefits of supplemental instruction. CSN has identified 3 full time Math faculty who are interested in attending the National Supplemental Instruction conference at the University of Missouri Kansas City this summer.
6. Continue participation in EdReady. CSN has agreed to participate with SRI Research to determine the efficacy of EdReady in preparing students for college level Math. Data sharing agreements have been signed and the project can commence.
7. Consider a change in software in Math Prep from MyMathLab to ALEKS.
8. Continue collaboration with United Way Southern Nevada to consider a summer bridge with select CCSD high schools in summer 2017
9. Explore concept of Meta Majors with Complete College America
10. Math Resource Centers have been established on all three main campuses of CSN. They are staffed by a Coordinator and trained peer tutors. CSN students have free and unlimited tutorial service available in these Math Resource Centers. Utilization of the Math Resource Centers, spring 2015 to spring 2016 shows an increase of 58% to day. 3804 visits in spring 2015 compared to 6012 in spring 2016 to date.
11. CSN is investing professional development monies into five (5) STEM faculty (one from Math) to attend a STEM course success conference this summer in Denver. The goal of this conference is to enable STEM faculty to evaluate their course content for relevancy and look for ways to help students be successful toward completion.
12. CSN collaborated with UNLV on an NSF grant which would provide professional development to STEM faculty in developing and incorporating problem based learning scenarios into course content. One of these identified STEM faculty is from Math.
13. CSN is considering a grant opportunity, provided by ATD, to provide professional development to part time faculty in Math. The webinar on this RFP is scheduled in the upcoming week. Six proposals will be funded to Leader Colleges, of which CSN is designated.

**COLLEGE OF SOUTHERN NEVADA**

**RESOURCES SUPPORTING IMPLEMENTATION OF TITLE 4, CHAPTER 16, SECTION 1**

**DIRECTIONS:** Indicate the existing and new resources that will be dedicated to your action plan for implementing the provisions of Title 4, Chapter 16, Section 1. You may edit the template as you see fit to appropriately represent institutional resources dedicated to implementation.

**PERSONNEL**

|                         | Existing  |           |           |           | New*      |           |           |           |
|-------------------------|-----------|-----------|-----------|-----------|-----------|-----------|-----------|-----------|
|                         | Headcount |           | FTE       |           | Headcount |           | FTE       |           |
|                         | Full-time | Part-time | Full-time | Part-Time | Full-time | Part-time | Full-time | Part-Time |
| Faculty - mathematics** | 35        | 34        |           |           | 39        | 35        |           |           |
| Faculty - English**     | 61        | 135       |           |           | 65        | 142       |           |           |
| Advisors                | 17        | 0         |           |           | 17        | 0         |           |           |
| Academic Counselors     | 25***     | 0         |           |           | 27***     | 0         |           |           |
| Other (please indicate) |           |           |           |           |           |           |           |           |
| Other (please indicate) |           |           |           |           |           |           |           |           |

\*New hires or reallocation of existing positions to support implementation of T4, Ch 16, Section 1 and institutional action plan

\*\*Faculty who teach gateway courses, FTE figure should be for the portion of their time dedicated to gateway course instruction

\*\*\*Includes Health Science

**OTHER COSTS OR RESOURCES**

Software or Programming Support - Please indicate other costs such as software or programming support to provide intrusive advising, and other automation of the enrollment requirements or continuous enrollment

|                                  | 2016-17 | 2017-18 | 2018-19 |
|----------------------------------|---------|---------|---------|
| Faculty Professional Development | 10,000  | 7,500   | 5,000   |
| Hobson's CRM                     | 183,900 | 183,900 | 183,900 |
| ALEK Software for Math Prep      |         |         |         |
|                                  |         |         |         |

|                                   | 2016-17 | 2017-18 | 2018-19 |
|-----------------------------------|---------|---------|---------|
| Other Resources (please indicate) |         |         |         |
| Other Resources (please indicate) |         |         |         |
| Other Resources (please indicate) |         |         |         |
| Other Resources (please indicate) |         |         |         |



**GBC**

**Institutional Gateway Course Action Plan**

# GREAT BASIN COLLEGE

## GATEWAY COURSE SUCCESS ACTION PLAN

April 4, 2016

As a component of the NSHE *Gateway Course Success* effort, this report presents the outline of the Great Basin College plan to achieve higher success in student completion of college-level English and mathematics, though focusing more on mathematics. This plan provides the guidelines for implementation of the provisions of *Title 4, Chapter 16, Section 1* in the NSHE *Handbook*.

The plan presented here focuses on five elements:

- 1- Policy Framework
- 2- Enforcement Measures
- 3- Advising and Student Outreach Plan
- 4- Communication Strategies
- 5- Data Benchmarks

For each of these five elements this report states the gaps identified between the Board policy and current GBC policies and practices. This report also provides plans and deadlines for addressing the identified gaps.

### **Policy Framework**

GBC academic policies and procedures relating to placement, admission, enrollment, and related topics, are located in the GBC College Catalog. Certain GBC policies mentioned in this report are not in the current catalog, but will be in the catalog being issued for the 2016-2017 academic year.

#### Exemption from Remedial Instruction

GBC students who meet or exceed minimum English or mathematics placement scores are placed into college-level courses in those subjects without further consideration. This has been the GBC policy and practice, and no revision is required to meet the NSHE policy.

#### Placement in Remedial Instruction

Students placed in remedial levels of English or mathematics have pathways available to complete gateway courses within one academic year. This ability is in part due to recently initiated pilot programs. The pathways employed are illustrated in Figure 1. Some pathways may include shortcuts or compressions of time. Descriptions of some of these shortened pathways follow here.

#### Condensed courses

MATH 097 (5 credits) may be taken in one semester instead of the two-semester sequence of MATH 095 and 096 (6 credits). In a similar manner, MATH 126E substitutes for the MATH 096/126 pair.

Shorted steps

After careful examination of the content of the courses, students may now proceed from MATH 095 to MATH 120 without taking MATH 096, saving them a full semester. It was also decided that students successfully completing MATH 116 may go directly to MATH 120 or 126. Though this does not affect the rate of completion of gateway mathematics, it has an important effect on students moving from certain Associate’s degrees to Bachelor’s degree options.

A recent pilot project utilizing TAACCCT funding embeds MATH 116 outcomes into technical programs. Students in the targeted classes take a MATH 116 challenge test after completing the class, and those passing are given credit for MATH 116. This effort has been successful, but the effort is not sustainable after the completion of the TAACCCT grant. This approach requires a full-time position to guide it, and does not generate revenue to support itself (and in fact reduces income from enrollment). This is a challenge that does not yet have a solution.

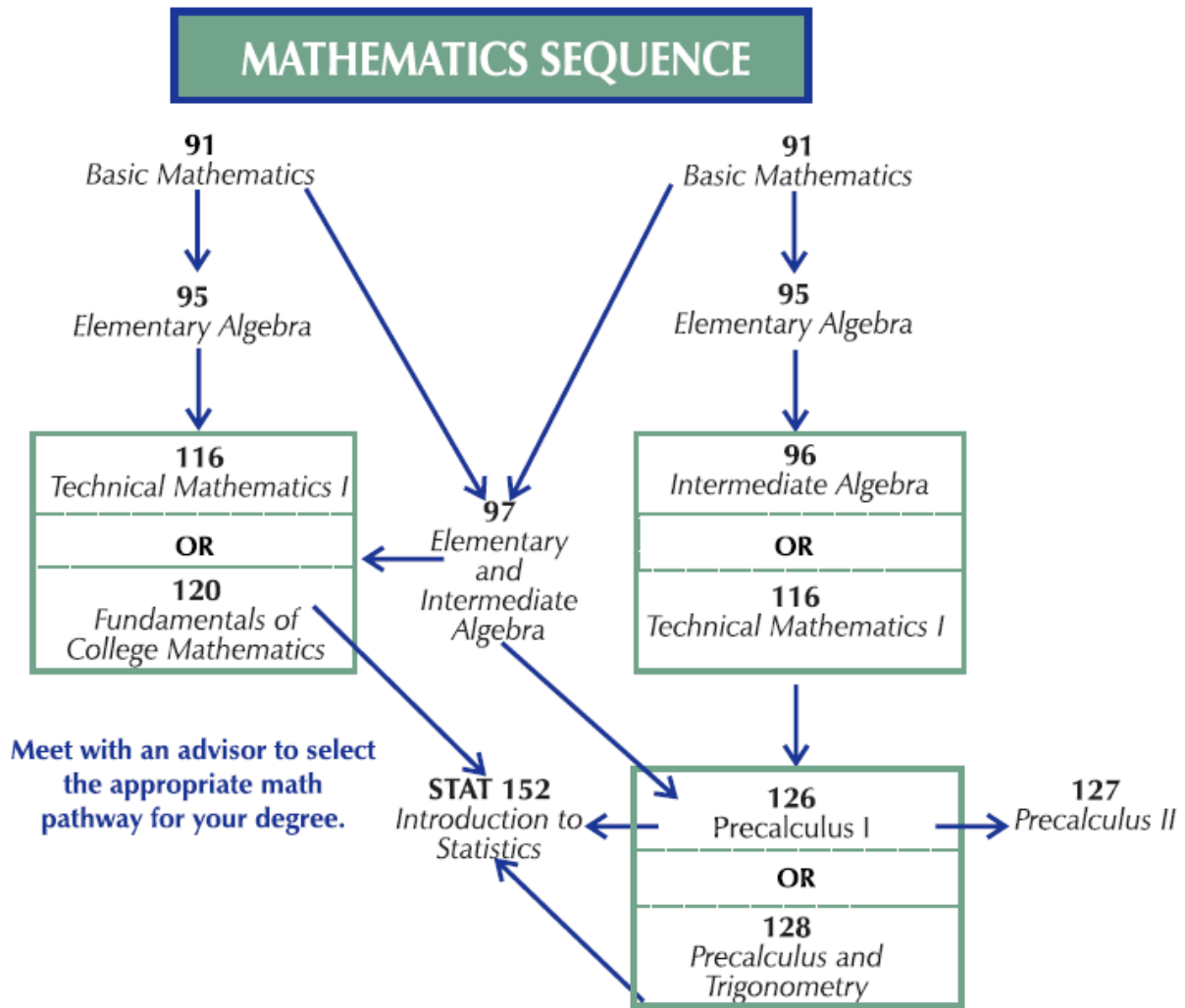

Figure 1. Representation of GBC mathematics course sequences that students may follow.

### Compressed schedules

An approach piloted during the current year offers courses in a compressed eight-week format. Indications are that this is successful. This allows students to take two courses in one semester and increase the pace at which they may enter college-level courses. One advantage of two courses condensed into a single semester is that students not succeeding early in an eight-week session have an option to repeat the course in the second eight weeks of the semester, or take other options. This approach requires careful schedule planning.

### Placement below High School Level (MATH 091)

The continuing placement of large proportions of students into MATH 091 (Basic Mathematics) is troubling. Most students placed into this course are using the Accuplacer instrument. It has been expressed that students may place there in part because it has been too long since they practiced the skills needed at that level, having spent time taking algebra. To test this, a current successful pilot allows students to take the Accuplacer placement test, then continue taking the algebra level portion of the test even if they are not successful in the basic mathematics portion. This has resulted in about 50% of those formerly stopping at the MATH 091 level to place into an algebra course, in some cases as high as MATH 126. It appears that many students struggling with fractions and percent calculations are capable of performing acceptably in some level of algebra.

Alternatives to using the Accuplacer placement instrument are being considered. Tools, such as ALEKS, are being examined that may combine placement with tutorials for advancement without taking classes. Covering the cost of this program is a consideration.

### Continuous Enrollment

The requirement for continuous enrollment in mathematics for degree-seeking students until completion of college requirements shall be listed in the coming GBC College Catalog.

### **Enforcement Measures**

The required policies for this report and plan are in place. Enforcement of some will be difficult in an absolute sense, but strategies exist. There is no adequate mechanism that can be put in place through existing registration systems to impose the initial and continuous enrollment requirements on students. The enforcement tools that will be employed are communication of requirements of gateway course enrollment and pervasive advising. Strategies for these are addressed in the next sections of this report.

The time table for enforcement of initial and continuous enrollment follows the time tables stated for advising and communication that follow. The open door admissions policy creates an initial challenge, since students from all backgrounds and levels of academic preparation must be admitted. This is compounded by the fact that 70% of GBC students enroll part-time. Most of these students do not have a clear idea of their academic goals, even though they may state a degree they seek. They are searching

for their future endeavors and may need some freedom to explore options and find a subject for which they carry enthusiasm.

### **Advising and Student Outreach**

GBC has a significant advising “gap.” Advising is being covered by part-time advisors, faculty advising, and advising through the GBC Centers. While the advising being given is good, it could be more consistent and pervasive. There continue to be too many self-advised students, despite communicating to them they should do otherwise. All students are required to complete the GBC Orientation, and one requirement is to receive initial advising. However, continuous of advising after this is uncertain.

GBC is receiving 4% increases in student fees in each of four years. These fees are to be used in the fall of 2016 and fall of 2017 to hire two more personnel in the Student Services area for advising and related student support.

The following are other specific actions that have been taken in regard to student advising as it relates to gateway courses:

- The early requirement for completion of gateway courses has been added to the degree audits
- The gateway policy requirements have been added to the list of advising tips
- The gateway requirements are covered in the faculty advising in-service sessions

### **Communication Strategies**

Through the schedule, advising, and the required and updated GBC Orientation, GBC continuously communicates to students the necessity of completing English and mathematics courses as soon as possible. This has always been the message delivered. Registered students who have not appropriately enrolled in gateway courses now receive direct email notices informing them of this requirement. Email of this policy requirement has been sent to all relevant staff. The requirement for initial and continuous enrollment is plainly stated in the college catalog and on GBC webpages.

For many years, GBC has hosted an annual meeting of high school counselors from throughout the service area, now up to 10 counties. A strong message delivered is the importance of student preparation for college-level work. In parallel with this effort, GBC has worked with school districts for many years in determining the placement level of high school students in their junior year. The hope is that students will use this information to better prepare themselves for college during their senior year.

A recent effort that will continue is to communicate to students the availability of alternate pathways for completing mathematics courses. The options mentioned earlier in this report for condensed courses and schedules are only effective if students know about them. Communication of the options will come from the catalog, the schedule, advising, exposure on the website and other means. Communication will also come from mathematics faculty relaying these options to students in lower level classes.

## **Data Benchmarks**

The current rate for GBC first-time, degree-seeking students enrolling in any mathematics course in the first year is about 65%. This has improved from 41% in the fall of 2011. From the fall of 2010 to the fall of 2014, the GBC rate of progression from remedial to college-level courses increased from 72% to 89%. It is desired to continue to increase the rate of initial enrollment while retaining the improved rate of progression.

Through student advising and communication, GBC seeks to increase the rate of first-time, full-time, degree-seeking students enrolling in mathematics during the first year to 95% within three years. With the current rate of progression to college-level courses and with condensed and compressed scheduling, GBC seeks to achieve 85% of this group of students completing a college-level class within one year. The caveat is that GBC must have significantly more resources for advising to achieve this.

Part-time students are a separate challenge, which are 70% of the GBC student population. As compared to full-time students, these students tend to be less motivated, less focused on a goal, less prepared, and with many more personal distractions. Also, if taking only one or two courses at a time, it will be difficult to expect them to enroll in both English and mathematics in the first year before other class considerations and still retain sufficient interest to have them proceed to program completion.

Under ordinary circumstances, it will be difficult to get a high proportion of full-time students to complete a college-level mathematics course within one year of initial enrollment if they begin at a remedial level. This is due to simple attrition. 85% is considered a high rate of successful completion of a mathematics class. If 100 students begin with a MATH 095 class, with 85% completion of each level, only 61 of those students (61%) would complete a MATH 126 class. Of course this result will vary with the level of the initial course and the final level to be attained.

## **Conclusions**

In summary, establishing higher, attainable benchmarks that account for all variables in community college student populations is a challenge. GBC seeks within three years to have 95% of first-time, full-time, degree-seeking students enrolled in gateway English and mathematics courses during their first year of enrollment.

GBC has all required policies in place for concurrence with NSHE policies regarding placement and progression through English and mathematics courses. GBC will seek initial and continuous enrollment through advising and communication, initially focusing efforts on full-time students. Part-time students have more barriers and unpredictability than do full-time students.

GBC has had improved success in working with students requiring remediation over the last five years, and currently 55% of all GBC graduates began in at least one remedial course. GBC seeks to continue the trend of improved success rates. Primary strategies center on stronger advising and greater utilization of condensed courses and compressed scheduling. Better methods of initial placement testing and remedial advancement utilizing tutorial approaches are being explored.

## GREAT BASIN COLLEGE

### RESOURCES SUPPORTING IMPLEMENTATION OF TITLE 4, CHAPTER 16, SECTION 1

**DIRECTIONS:** Indicate the existing and new resources that will be dedicated to your action plan for implementing the provisions of Title 4, Chapter 16, Section 1. You may edit the template as you see fit to appropriately represent institutional resources dedicated to implementation.

**PERSONNEL**

|                         | Existing  |           |                 |           | New*      |           |                    |           |
|-------------------------|-----------|-----------|-----------------|-----------|-----------|-----------|--------------------|-----------|
|                         | Headcount |           | FTE (Fall 2015) |           | Headcount |           | FTE (per semester) |           |
|                         | Full-time | Part-time | Full-time       | Part-Time | Full-time | Part-time | Full-time          | Part-Time |
| Faculty - mathematics** | 2         | 5         | 1.6             | 1.4       | 0         | 2         | 0.4                | 0.4       |
| Faculty - English**     | 5         | 6         | 2.8             | 1.4       | 0         | 2         | 0.4                | 0.4       |
| Advisors                | 0         | 2         | 0.0             | 1.0       | 1         | 0         | 1.0                | 0.0       |
| Other (please indicate) |           |           |                 |           |           |           |                    |           |
| Other (please indicate) |           |           |                 |           |           |           |                    |           |
| Other (please indicate) |           |           |                 |           |           |           |                    |           |

\*New hires or reallocation of existing positions to support implementation of T4, Ch 16, Section 1 and institutional action plan

\*\*Faculty who teach gateway courses, FTE figure should be for the portion of their time dedicated to gateway course instruction

**OTHER COSTS OR RESOURCES**

Software or Programming Support - Please indicate other costs such as software or programming support to provide intrusive advising, and other automation of the enrollment requirements or continuous enrollment

|                                | 2016-17  | 2017-18  | 2018-19  |
|--------------------------------|----------|----------|----------|
| ALEKS                          | \$10,000 | \$10,000 | \$10,000 |
| Cranium Café (online advising) | \$10,000 | \$15,000 | \$20,000 |
| Other Costs (please indicate)  |          |          |          |
| Other Costs (please indicate)  |          |          |          |

|                                   | 2016-17 | 2017-18 | 2018-19 |
|-----------------------------------|---------|---------|---------|
| Other Resources (please indicate) |         |         |         |
| Other Resources (please indicate) |         |         |         |
| Other Resources (please indicate) |         |         |         |
| Other Resources (please indicate) |         |         |         |

# TMCC

## Institutional Gateway Course Action Plan



# Truckee Meadows Community College

## Gateway Course Action Plan

### Introduction

In June, 2015, the Nevada System of Higher Education (NSHE) Board of Regents (BOR) approved a Placement into College-Level Courses policy (BOR Handbook Title 4, Chapter 16, Section 1). This policy requires its institutions of higher education to place students into college-level courses who have achieved minimum math and English scores on college readiness assessments (ACT, SAT, Smarter Balanced, PARCC), who were continuously enrolled in English and math courses in their senior year of high school, and who enrolled in college in the academic year following high school graduation; or, develop alternative placement measures and policies. In addition, institutions must publish their policies and ensure that all degree-seeking students must be continually enrolled in math and English courses until core curriculum requirements in these courses have been achieved. TMCC has several practices in place that already address this policy and proposes the following plan towards full compliance.

### Currently in Place

Title 4, Chapter 16, Section 1

1. Ability to benefit using federally-approved tests and passing scores for financial aid.  
TMCC currently utilizes the ACCUPLACER, ACT and SAT scores.
2. Initial Placement of Students into English and Mathematics Courses
  - a. Exemption from Remedial Instruction.  
TMCC honors all minimum scores for placement into a college-level course outlined by the policy. In addition, TMCC honors Alternate Pathways for Washoe County School District high school graduates:  
  
WCSD graduates with an overall unweighted GPA  $\geq 3.0$  may enroll in ENG 101, Recommended Read 135 or ENG 113, Recommended Non-Native Read 135.  
  
WCSD graduates with an overall unweighted GPA  $\geq 3.0$  and complete Intermediate Algebra (Algebra 3-4 in WCSD) with a grade of B or higher may enroll in MATH 120 or MATH 126.
  - b. Placement of Students without an Exemption from Remedial Instruction.  
TMCC utilizes the ACCUPLACER to determine placement for students not placed by the SAT, ACT, PARCC, Smarter Balanced exams or by Alternate Pathways. Pathways that allow completion of gateway English and math courses are established (APPENDIX A) and include:

- Remedial English pathway was shortened to 1 class or as a co-requisite by eliminating ENG 095 and offering ENG 098 as a co-requisite in Fall 2015.
- Math 93 was eliminated from the remedial Math pathway. Math 92 is now being taught concurrently with MATH 95/96 stretch and MATH 120 stretch. MATH 96 D is offered concurrently with MATH 126E to create a stretch version at this level.
- A Math 95 to 120 pathway was established for Fall 2016.
- “Mini” session courses of ENG 98R/101, ENG 101/102, MATH 95/96, MATH 96/120 and MATH 96/126 were established in Fall 2014.
- TMCC will continue to have “mini” and stretch course offerings in Math and English in Fall 2016.

TMCC also has a committed and responsive Vice President of Academic Affairs (VPAA), who directed the increase of 17 additional ENG 101 sections (48.6%) in Fall 2015 compared to Fall 2014. In Fall 2016, Math has put up an additional 8 sections of MATH 126 compared to Fall 2015. There are plans to add additional Math and English sections as demand warrants.

The college is already conducting searches for 4 tenure-track faculty positions each in Math and English, which are dedicated primarily to gateway courses. The VPAA is also committed to adding full-time temporary Math and English instructors dedicated to gateway courses as needed.

- c. For students whose mathematics skills are below the high school level. TMCC operates a Math Skills Center.
3. All degree-seeking students must be continuously enrolled until all core English and math requirements are completed.
    - TMCC has the ability to put registration holds and drop holds through PeopleSoft.
    - TMCC has mandatory Student Orientation, Advisement and Registration (SOAR), where all first-time degree-seeking students register for their first semester, including appropriate Math and English courses.
    - First-time full-time students have additional 2 holds (at census date to register for semester 2 and again in Spring semester) to be advised on remaining course requirements for degree completion.
    - Financial aid students who have filed an appeal must be enrolled in math and English for their appeal to be considered.
    - All students receiving the Freshman Incentive Grant, TMCC Incentive Grant or Graduation Incentive Grant must be enrolled in or have completed their English and math sequence.

4. Requirements for college readiness and college-level course enrollment shall be publicized.
- Alternate Pathways are published on TMCC's [Testing Services](#) web page, and a letter is sent to WCSD students notifying them of their placement through Alternate Pathways. ACCUPLACER, SAT and ACT cut scores are published on the [Math Department](#) and [English Department](#) web pages.

## Gap Analysis and Resource Plan

The number of first-time, degree-seeking students in Fall 2014 at TMCC was 1,125. In Math, 709 students were enrolled in Math in the first year; the **Math gap is 416 students** (Figure 1). In English, 801 students were enrolled in an English class in the first year; the **English gap is 324 students** (Figure 2).

| Percent and Number of First-Time, Degree-Seeking Students Enrolled in Math in First Year<br>(Fall, Spring and Summer) |            |            |            |         |            |            |         |            |            |                   |            |            |                   |                   |            |            |                   |
|---|------------|------------|------------|---------|------------|------------|---------|------------|------------|-------------------|------------|------------|-------------------|-------------------|------------|------------|-------------------|
|   | Historical |            |            |         |            |            |         |            |            | Benchmarks        |            |            |                   |                   |            |            |                   |
|   | 2012-13    |            |            | 2013-14 |            |            | 2014-15 |            |            | 2016-17           |            |            |                   | 2017-18           |            |            |                   |
|   | Cohort*    | # Students | % Students | Cohort* | # Students | % Students | Cohort* | # Students | % Students | Estimated Cohort* | # Students | % Students | # Course Sections | Estimated Cohort* | # Students | % Students | # Course Sections |
| UNLV  | 2,688      | 2,180      | 81.1%      | 3,139   | 2,624      | 83.6%      | 3,484   | 3,060      | 87.8%      |                   |            |            |                   |                   |            |            |                   |
| UNR   | 2,425      | 2,314      | 95.4%      | 2,613   | 2,488      | 95.2%      | 3,029   | 2,708      | 89.4%      |                   |            |            |                   |                   |            |            |                   |
| NSC   | 132        | 89         | 67.4%      | 226     | 165        | 73.0%      | 262     | 190        | 72.5%      |                   |            |            |                   |                   |            |            |                   |
| CSN   | 4,354      | 1,407      | 32.3%      | 4,979   | 1,480      | 29.7%      | 4,954   | 1,713      | 34.6%      |                   |            |            |                   |                   |            |            |                   |
| GBC   | 230        | 141        | 61.3%      | 199     | 135        | 67.8%      | 191     | 124        | 64.9%      |                   |            |            |                   |                   |            |            |                   |
| TMCC  | 1,231      | 847        | 68.8%      | 1,218   | 761        | 62.5%      | 1,125   | 709        | 63.0%      | 1137              | 853        | 75.0%      | 17                | 1149              | 977        | 85.0%      | 17                |
| WNC   | 598        | 418        | 69.9%      | 633     | 432        | 68.2%      | 442     | 289        | 65.4%**    |                   |            |            |                   |                   |            |            |                   |

\*new, degree-seeking students entering in the Fall semester

**Figure 1. Math: TMCC Benchmark Setting and Gap Analysis, 2016-17 and 2017-18.**

| Percent and Number of First-Time, Degree-Seeking Students Enrolled in English in First Year<br>(Fall, Spring and Summer) |            |            |            |         |            |            |         |            |            |                   |            |            |                   |                   |            |            |                   |
|--|------------|------------|------------|---------|------------|------------|---------|------------|------------|-------------------|------------|------------|-------------------|-------------------|------------|------------|-------------------|
|  | Historical |            |            |         |            |            |         |            |            | Benchmarks        |            |            |                   |                   |            |            |                   |
|  | 2012-13    |            |            | 2013-14 |            |            | 2014-15 |            |            | 2016-17           |            |            |                   | 2017-18           |            |            |                   |
|  | Cohort*    | # Students | % Students | Cohort* | # Students | % Students | Cohort* | # Students | % Students | Estimated Cohort* | # Students | % Students | # Course Sections | Estimated Cohort* | # Students | % Students | # Course Sections |
| UNLV   | 2,688      | 2,444      | 90.9%      | 3,139   | 2,894      | 92.2%      | 3,495   | 3,224      | 92.2%      |                   |            |            |                   |                   |            |            |                   |
| UNR  | 2,425      | 2,277      | 93.9%      | 2,613   | 2,476      | 94.8%      | 3,030   | 2,687      | 88.7%      |                   |            |            |                   |                   |            |            |                   |
| NSC  | 132        | 101        | 76.5%      | 226     | 157        | 69.5%      | 265     | 192        | 72.5%      |                   |            |            |                   |                   |            |            |                   |
| CSN  | 4,354      | 2,260      | 51.9%      | 4,979   | 2,639      | 53.0%      | 5,018   | 2,870      | 57.2%      |                   |            |            |                   |                   |            |            |                   |
| GBC  | 230        | 168        | 73.0%      | 199     | 161        | 80.9%      | 191     | 152        | 79.6%      |                   |            |            |                   |                   |            |            |                   |
| TMCC   | 1,231      | 933        | 75.8%      | 1,362   | 940        | 69.0%      | 1,125   | 801        | 71.2%      | 1137              | 966        | 85.0%      | 13                | 1149              | 1034       | 90.0%      | 13                |
| WNC  | 598        | 454        | 75.9%      | 667     | 504        | 75.6%      | 445     | 323        | 72.6%**    |                   |            |            |                   |                   |            |            |                   |

\*new, degree-seeking students entering in the Fall semester

**Figure 2. English: TMCC Benchmark Setting and Gap Analysis, 2016-17 and 2017-18.**

### Resource Plan for Closing the Gap: Sections Needed

According to the gap analysis:

**Math:** 416 students / 25 students per section = **17 additional sections** needed to close the gap (Figure 1).

(Number of students per section was based on the average number of students in a typical section of MATH 95, 96, 120 and 126.)

**English:** 324 students / 26 students per section = **13 additional sections** needed to close the gap

(Number of students per section was based on the average number of students in a typical section of ENG 98R, READ 135 and ENG 101.)

**Resource Plan for Closing the Gap: New Hires**

Eight more full-time tenure-track faculty in the Math and English Departments are being hired to teach English and math gateway classes for Fall 2016. Plus we have assured our chairs that they will have the capacity to add an additional 2 Temporary FT faculty in both areas. This will greatly increase the number of sections and students served. A minimum of eighty percent (4 classes) of their workload will be dedicated to gateway courses. This will allow us to offer 48 additional sections of gateway or remedial pathway courses in math and English. The additional sections will not only meet the demand of the first-time student cohort, but also help to meet the demands of the College as a whole. According to our unserved students, we will prioritize additional course offerings in ENG 101, MATH 96 and MATH 126 for Fall 2016 (Table 1). The Vice President of Academic Affairs is committed to hiring additional full-time temporary instructors who will be dedicated to gateway and pathway courses as needed.

**Table 1. Unserved Students by Gateway or Gateway Pathway Course.**

| Unserved Students by Gateway Course Name |                   |                            |                       |                       |
|--|-------------------|----------------------------|-----------------------|-----------------------|
| Gateway Course                           | Unserved Students | Didn't Enroll in Fall 2015 | Enrolled in Fall 2015 |                       |
|  |                   |                            | New Degree-Seeker     | NOT New Degree-Seeker |
| CTM086                                   | 25                | 2                          | 15                    | 8                     |
| ENG 098R                                 | 52                | 11                         | 18                    | 23                    |
| ENG 101                                  | 154               | 52                         | 45                    | 57                    |
| ENG 102                                  | 38                | 8                          | 6                     | 24                    |
| ENG 107                                  | 7                 | 1                          | 1                     | 5                     |
| ESC 001                                  | 2                 | 2                          | 0                     | 0                     |
| MATH092                                  | 11                | 2                          | 1                     | 8                     |
| MATH095                                  | 42                | 8                          | 10                    | 24                    |
| MATH096                                  | 91                | 15                         | 12                    | 64                    |
| MATH120                                  | 13                | 3                          | 2                     | 8                     |
| MATH126                                  | 91                | 18                         | 13                    | 60                    |

Two additional academic advisors have been requested to help with this effort and pending funding approval. If approved, the two additional advisors would be primarily responsible for the first-time student cohort and ensuring students are continuously enrolled in and completing gateway courses in both English and math through the use of registration holds.

An additional classified staff person has been requested by Admissions and Records to help create and update the Academic Advisement reports. An accurate report, indicating classes required to complete the gateway pathway, will assist students who self-service and do not see an academic advisor.

### **Resource Plan for Closing the Gap: Dedicated Gateway Classrooms and Scheduling**

The VPAA is dedicating 4 classrooms to math and English gateway course offerings Monday-Thursday during the prime times (9:30-3:15 p.m.). Four classrooms have been identified. There are: Sierra (SIER) 211, 212, 215 and VSTA 102. These classrooms will facilitate a minimum of 10 additional sections for each area to be offered during the prime time hours. The other 7 math and 3 English sections identified above will be added to regular scheduling, and enrollments will be monitored daily to ensure that full student access is available.

We will continue to look at room utilization /efficiency in our scheduling practices and move classes with smaller enrollments outside of prime times (9:30 a.m. - 3:15 p.m.) and open up prime time rooms for gateway courses in demand. For instance, we have SIER 107 which can accommodate many of our ESL and developmental classes. TMCC plans to move its CNA program to Meadowood site, which will free up rooms on the Dandini campus. Academic deans are working together to schedule gateway (and other) courses at the Meadowood site so that students can complete their core curriculum requirements entirely at this location. We may expand this concept to the Pennington Health Sciences Center.

## **Implementation of College Policies**

- a. **Advising Protocols:** The College has a comprehensive approach to advising with defined roles and outcomes. All academic advisors receive intensive training prior to meeting with students on all degree programs and math and English requirements. On-going training is provided on specific degree programs on a weekly basis to ensure accuracy of information for students. Placement policies and cut scores are disseminated to all advisors whenever there is a change or addition. The advisement staff is very familiar with the policy through weekly updates during staff meetings and actively promote math and English registration through one-on-one advising appointments and in the orientation program. The advisement staff members also coordinate all orientation programs where students receive placement materials and register for classes. When students attend the registration workshop, the majority of time is spent explaining the pathways available to students, registering for math/English,

and encouraging a full-time credit load. The Powerpoint slides for the advising and registration workshop show that significant time is dedicated to placement and registration (APPENDIX B). The advisors were surveyed regarding their knowledge of the policy, and 100% indicated familiarity with the policy and described the importance of math and English registration (APPENDIX C). We are thus confident in our current advisors' understanding of the policy and of the advising practices used toward policy implementation.

More critical to a successful implementation of the policy is an adequate number of advisors to manage registration holds. At a minimum, two additional advisors would be needed to manage registration holds for students towards ensuring continuous enrollment in the gateway classes. For a cohort size of approximately 1200 students, each advisor would be responsible for managing 600 of those students. We have requested the two additional advisors through our Resource Allocation Process and will know in May if the positions are approved and will be funded.

- b. Communication Plan:** The information coming from various departments at TMCC needs to be consistent to ensure students are receiving consistent information about the policy. Our communication plan will include both internal and external targets to inform students, faculty and staff of the continuous enrollment policy. We have already begun to implement the communication piece by incorporating this message into the Spring 2016 new student orientation (SOAR), through our Canvas LMS and in a memo to WCSD counselors.

Internal communication targets:

- We will focus on “first-liners” and solicit their help in communicating to students. First-liners include: instructors who teach developmental courses, administrative assistants, Financial Aid staff, Admissions & Records staff and Welcome Center staff.
- We will target new first-time degree-seeking students (through orientation), students who do not currently have an orientation requirement, and students currently enrolled in developmental courses.
- Communications will be sent to students through the Canvas LMS (already begun) and in-person during class meetings regarding the next math or English class in sequence (March - May 2016).
- Multiple measures for math/English placement will be made available on the Testing Center website (Ongoing).
- Students will be provided a Math and English Pathways flow chart (Appendix A) after taking the Accuplacer placement exam (Ongoing, but heavy traffic in August, 2016) and at orientation (Ongoing).
- Advisors will help register students for math and English classes during orientation to start students on the appropriate pathway (Spring SOAR: March-August 2016, Fall SOAR: September 2016-January, 2017).

External communication targets:

- The communication will be added to our [Steps to Enroll: New Degree-Seeking Students](#) web page.
- We will work with the Recruitment Office to disseminate information to HS counselors and prospective students (especially WCSD). We can also communicate this message during our JumpStart efforts (ongoing; already begun) and at an annual breakfast that we host for them on campus (November 2016).
- WCSD students will be sent a letter with eligibility information on alternate pathways placement options after applying to TMCC (Appendix D; March-August 2016).
- We will send letters to the homeschooling community, which we have already reached out to with our JumpStart efforts.

**c. A System for Enforcement:** Currently, all first-time degree students have enrollment holds until they complete SOAR, where students register for their first semester, including Math and English courses. Furthermore, all first-time, full-time degree seeking students have enrollment holds prior to registering for their second and third semesters. We plan to phase in service indicator holds and then drop holds pending approval of funding and hiring of 2 additional advisors, according to the following timeline:

|             |   |
|-------------|---|
| Fall 2016   | The Early Alert system (Starfish module of CRM) will be implemented, and first-time degree-seeking students will be actively managed and contacted regarding continuous enrollment and gateway pathway reinforcement. |
|             | Service Indicator holds will be placed on new first-time degree-seeking students with message to students stating that they must enroll and complete gateway English and math course to proceed with registration.    |
| Spring 2017 | Degree Planner (Starfish module of CRM) will be implemented, which will be another and even more clear way for students to see and understand gateway pathways.   |
| Fall 2017   | Drop holds will be implemented for new first-time degree-seeking students pending hiring of 2 additional Academic Advisors.   |

## The Right Pathway

We have already offered “stretch” and “mini” sections of math and English courses (Figure 3) as pilots, which have shown some promise in terms of retention compared to traditional, single class offerings. The Math Department publishes a brochure of its mini and stretch courses offered per semester (Appendix E). We will scale up these offerings beginning Fall 2016 as demand requires using the newly hired tenure-track and full-time temporary Math and English faculty.

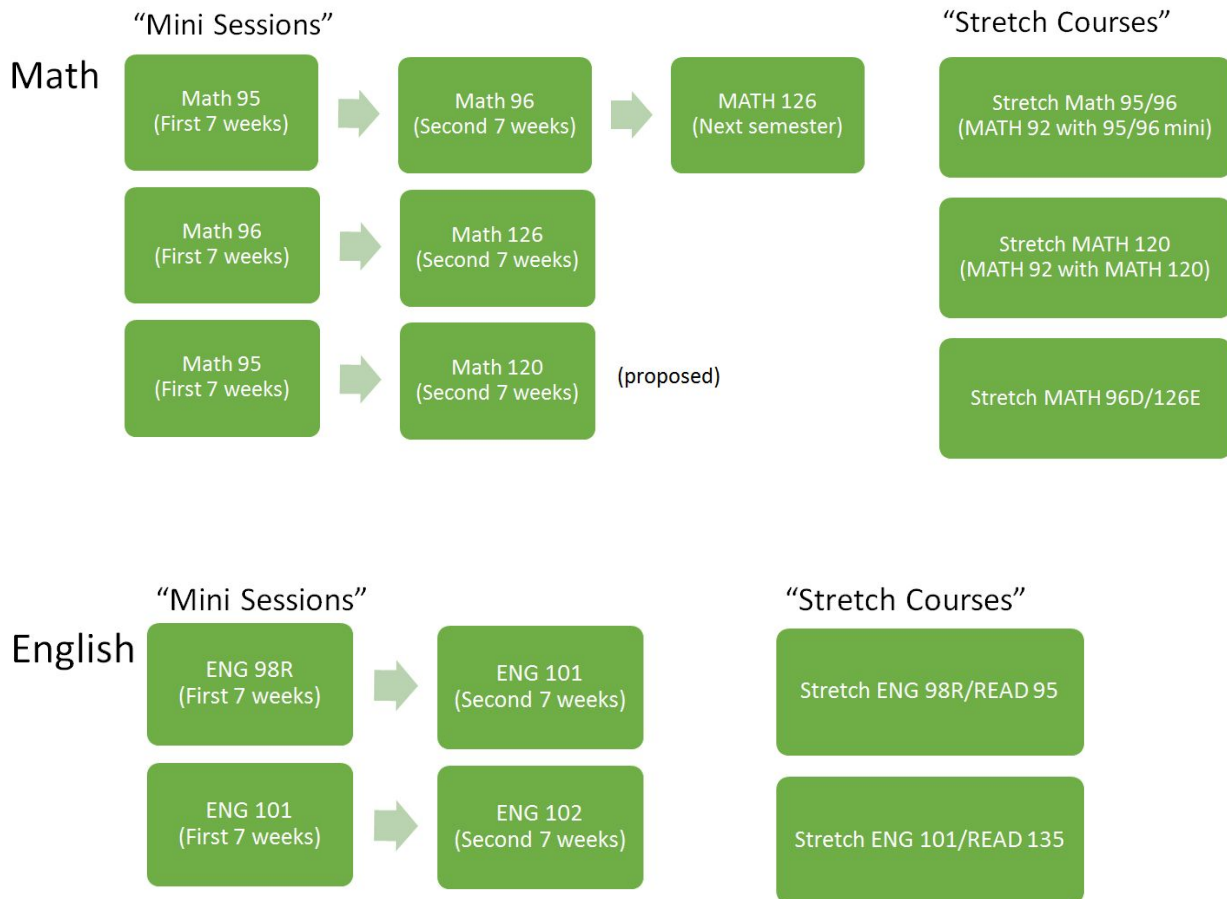

**Figure 3. Mini sessions and stretch courses in Math and English.**

We have run preliminary queries for the upcoming Financial Aid regulation (34 CFR 668) to find student who are in classes outside their degree program, and only a very small number of students were found to be taking Math or English courses outside of their degree. Out of 2,305 individual student records capturing classes students were enrolled in not going towards their current declared program of study from fall 2015, 1 student was in ENG 113, 7 in ENG 101, and 8 in MATH 120 that were not found to be going towards their declared degree programs. Therefore, we do not anticipate that additional resources will be needed to redirect students into the appropriate math and English courses for their degree, other than the two academic advisors already requested.



## Comprehensive Timeline of Action Plan

| Date              | Action   |
|-------------------|--|
| February 2016     | Develop English and math placement sequences flowchart and have available in department offices, Academic Advising Offices, Testing Center, Welcome Center and Financial Aid Office.   |
| March-August 2016 | Continue aggressive communication at New Student Orientation, including registration for math and English classes during first semester. WCSD students receiving letter of eligibility for alternate pathways that now includes policy information (APPENDIX D).   |
| March-April 2016  | Verify 3-semester eligible STEM degree plans for math with System Office.  |
| March 2016        | Add System Policy language to catalog. Implement popup communication in Canvas LMS and TMCC Student e-Newsletter (APPENDIX D).   |
| April 2016        | Modify <a href="#">Steps to Enroll: New Degree-Seeking Students</a> webpage to include policy information.   |
| May 2016          | Clarify ESL cut scores, pathway, and scheduling with faculty   |
| August 2016       | <p>Implement the Early Alert portion of the CRM Starfish module to actively manage and contact students regarding the policy.</p> <p>Place service indicator holds on new, first-time degree-seeking students with message stating that they must enroll and complete gateway English and math courses to proceed with registration.</p> |
| January 2017      | Implement the Degree Planner portion of the CRM Starfish module, which will be another and even more clear way for students to see and understand gateway pathways.  |
| August 2017       | Drop holds will be implemented for new first-time degree-seeking students pending hiring of 2 additional Academic Advisors.  |
| Through 2019      | Continuously monitor benchmark progress.   |

## **Appendices**

Appendix A - Math and English Flow Charts for Student Distribution

Appendix B - Student Orientation, Advisement and Registration (SOAR) PowerPoint Slides

Appendix C - NSHE Gateway Course Advisor Survey Results

Appendix D - NSHE Policy Communications

Appendix E - Math Options Fall 2016

# Math Placement

**Key:**

- Accu = Accuplacer
- AR = Arithmetic
- AG = Algebra
- CM = College Math
- WHSM = Washoe County School District high school GPA of 3.0+ with a B in Algebra 3-4

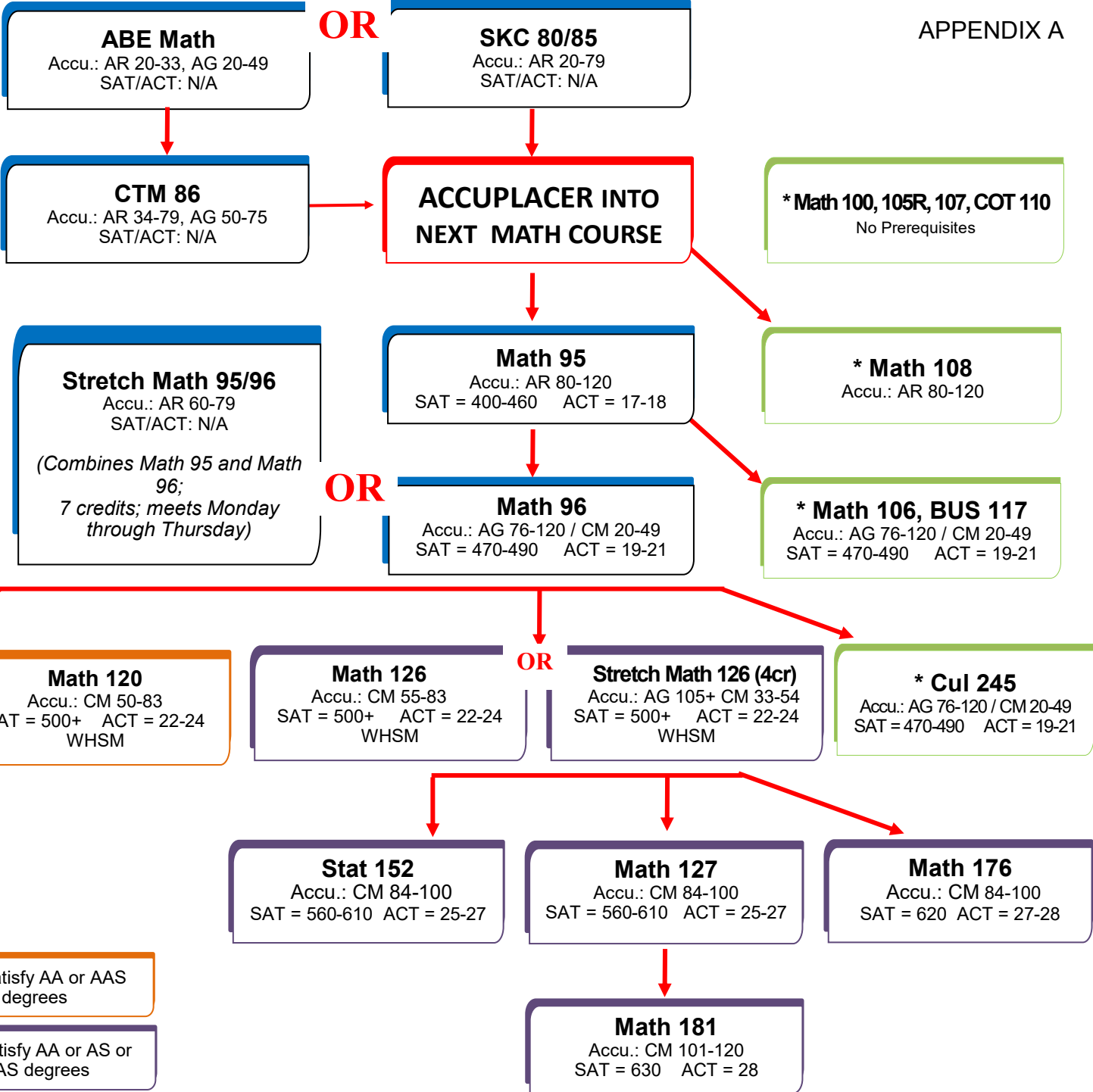

Below 100 level indicates developmental courses

May satisfy AA or AAS degrees

\* May satisfy AAS; will not satisfy transfer AA/AS

May satisfy AA or AS or AAS degrees

# English Placement

**Key:**

- Accu = Accuplacer
- RC = Reading Comprehension
- WCSD = Washoe County School District grade point average

**Eng 181**  
No prerequisite

**ABE English Program**  
Accu: RC 20-40  
SAT / ACT: NA

**English Skills Center ESC1**  
Accu: RC 41-55  
SAT / ACT: NA

**ACCUPLACER INTO NEXT ENGLISH COURSE**

**Eng 98 w/ Read 95**  
Accu: RC 56-75  
SAT: < 440 ACT: < 18

**Eng 98 (no Read)**  
Accu: RC 76-85  
SAT/ACT: NA

**OR**

**Eng 107**  
Accu: RC 86+  
SAT 440-670; ACT 18-29;  
\*\*WCSD HS GPA > 3.0

**Bus 106**  
Accu: RC 86+  
SAT 440-670; ACT 18-29;  
\*\*WCSD HS GPA > 3.0

**Eng 101 w/ Read 135**  
Accu: RC 76-85  
SAT/ACT: NA

**Eng 101**  
Accu: RC 86+  
SAT 440-670; ACT 18-29;  
\*\*WCSD HS GPA > 3.0

**OR**

**Bus 108**  
SAT 680+; ACT 30+

**ENG 102**  
SAT 680+; ACT 30+

*Below 100 level indicates developmental courses*

May satisfy AA or AS or AAS degrees

\* May satisfy AAS; will not satisfy transfer AA/AS

# English Placement for Non-Native English

Choose track 1 or 2 depending on your scores.

**Key:**

- LOEP = Accuplacer
- WCSD = Washoe County School District grade point average

## Track 1

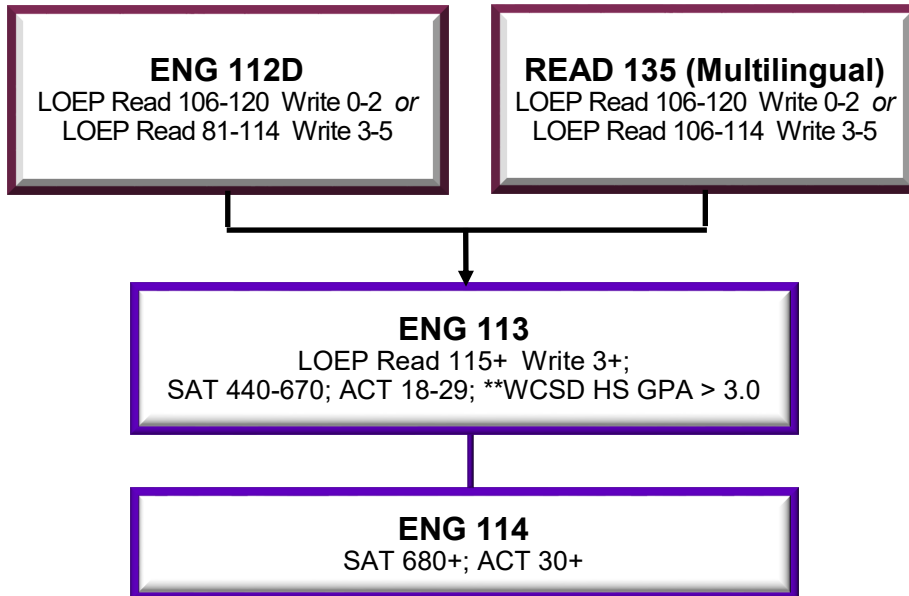

## Track 2

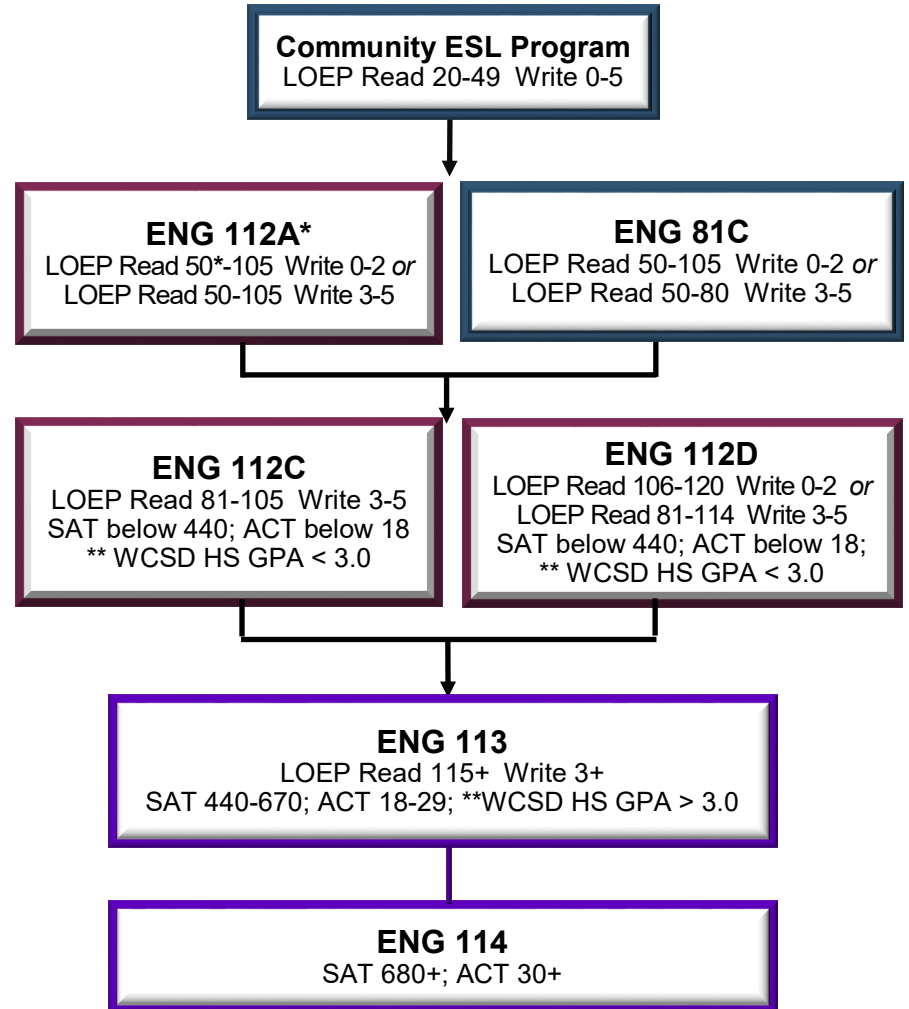

Developmental course.

Indicates college-level course work.

Course required for degree.

\* ESL department consent required for an LOEP Read scores of 50-80 with an WritePlacer score of 0-2.

\*\* Washoe County School District High School grade point average





### DEGREE PROGRAM WORKSHEET

**"Recommended"**  
Suggested but does not require General Education approval.

**"Required"**  
Must take this class.

**"Blank"**  
Chosen from General Education options.

**ASSOCIATE OF ARTS DEGREE**  
EMPHASIS REQUIREMENTS

**EMPHASIS REQUIREMENTS**

**GENERAL EDUCATION REQUIREMENTS**

**ADDITIONAL DEGREE REQUIREMENTS**

**COPE REQUIREMENTS**

**SUGGESTED COURSE SEQUENCE**

Page 2, Guidebook

## I know how to read a Program Worksheet

A. Yes

B. No

## LOGIN TO MyTMCC

(my.tmcc.edu)

LOG IN here

Click Student Center

Go to the MyTMCC Student Center to access all your student information.

## Finding your placement:

Academics

SEARCH FOR CLASSES

You are not enrolled in classes.

You have no outstanding charges at this time.

Communication Center

Math

No Holds

To Do List

No To Do's

Enrollment Data

## Reading your Placement:

### Test scores -

| TEST ID | Description              | Test Score | Test Date  | Score |
|---------|--------------------------|------------|------------|-------|
| ACCUMEN | Reading Comprehension    | 87.00      | 05/04/2014 | TMCC  |
| ACCUMEN | WRKng Sample             | 6.00       | 05/06/2014 | TMCC  |
| ACCUMEN | Algebra                  | 62.00      | 02/06/2014 | TMCC  |
| ACCUMEN | College Math             | 28.00      | 05/06/2014 | TMCC  |
| SAT     | Critical Reading         | 480.00     | 04/25/2014 | TMCC  |
| SAT     | Essay Subscore           | 7.00       | 04/25/2014 | TMCC  |
| SAT     | Math                     | 460.00     | 04/25/2014 | TMCC  |
| SAT     | Multiple Choice Subscore | 54.00      | 04/23/2014 | TMCC  |
| SAT     | Writing                  | 930.00     | 04/25/2014 | TMCC  |

### ALTERNATE PATHWAYS -

(2015 Washoe County School District high school graduates only)

| WHS | WGPA | Grade | WHS | Grade      |
|-----|------|-------|-----|------------|
| WHS | 3.98 | 11th  | WHS | 05/09/2014 |
| WHS | 4.00 | 11th  | WHS | 05/09/2014 |

\*If you do not see SAT/ACT or AP scores in MyTMCC, please send official scores to TMCC.

## Placement Example:

Choose the placement that best aligns with your program worksheet and write on page 4 of Guidebook.

Math Placement

APR Math OR SNC 0095

CTM 95 OR ACCUPLACER INTO NEXT MATH COURSE

Math 95 OR Math 95

Math 100 OR Math 100, 100, 111

Math 100 OR Math 100

Math 100 OR Math 100

Math 100 OR Math 100

Math 100 OR Math 100



APPENDIX B

## 30 cr. Policy for Math & Eng

### Create your first semester Educational Plan

**Now it's your turn!**

| Prerequisite    | Course 1 | Course 2 | Course 3 | Course 4 | Course 5 |
|-----------------|----------|----------|----------|----------|----------|
| First Semester  | MATH 101 | ENGL 101 | PHYS 101 | PHIL 101 | PSY 101  |
| Second Semester | MATH 102 | ENGL 102 | PHYS 102 | PHIL 102 | PSY 102  |

Remember, you will create an ed plan that works for you!

English & Math Placement — Along with ACCUPLACER SAT or ACT scores, enter your first semester English and Math placement course. You may enter your test scores in your MyTMCC Student Center. Please refer to the Math and English placement conditions for admission to the placement test. Register program worksheet for placement course.

English:  Math:

You have 30 credit hours to complete your 1st semester. Add your 1st semester ENGL 101.

**Page 6, Guidebook**

**Page 4, Guidebook**

Use program worksheet and GE sheet to help choose your courses

### I will be a full-time student

A. Yes  
B. No

| Response | Percentage |
|----------|------------|
| A. Yes   | 58%        |
| B. No    | 42%        |

### 15 TO FINISH TIME OBLIGATION

#### Finish in 2 years with 30 credits per year

- 15 credits per semester
- OR
- 12 credits each semester with 6 credits in summer or winter
- 1 credit/unit = 1 hour of class

**15** × **2** = **30**

15 credit hours X 2 hours of study per credit = 30 hours of study time

**15** + **30** = **45**

15 hours in class + 30 hours studying = 45 hours per week time obligation

**Page 7 of SOAR Guidebook**

### HOW TO ENROLL IN CLASSES

#### How to Enroll in Classes

- Go to MyTMCC at mytmcc.edu.
- Enter your TMCC username and password.
- Click on Student Center.
- Click on Search for Classes, located in the upper right corner.
- Select the semester term (Fall 2015, Spring 2016).
- Select the area of the site that you are trying to find by clicking on Search Student.
- Type in the number of the class you are trying to find (e.g., 101).
- Click Search.
- Review the class times, location and fees.
- Click Select Class.
- Click Block to add the class hours to your cart.
- Click My Shopping Cart, select the courses you want, and click Enroll.
- Click Finish Enrolling.

**Page 10 of SOAR Guidebook**

### Where do you go to enroll in classes?

A. TMCC Webpage  
B. MyTMCC  
C. Canvas

| Response        | Percentage |
|-----------------|------------|
| A. TMCC Webpage | 17%        |
| B. MyTMCC       | 67%        |
| C. Canvas       | 17%        |



### SEARCH FOR CLASSES

### ENTER SEARCH CRITERIA

### VIEW AND SELECT COURSE SECTION

Review status, days, times, location, dates, method

### ADD COURSE TO SHOPPING CART

### FINISH ENROLLING...

### Shopping Cart

#### Add Classes to Shopping Cart

Use the Shopping Cart to temporarily save classes until it is time to enroll for this term. Click validate to have the system check for possible conflicts prior to enrolling.

2016 Spring | Undergraduate | Truckee Meadows Comm College

| Select Class  | Days/Times | Room              | Instructor              | Units       | Status |
|---------------|------------|-------------------|-------------------------|-------------|--------|
| ENGL 99-12021 | MWTh       | 11:00AM - 12:15PM | Vista Building Room 302 | K. Cullinan | 3.00   |

Find Classes:  Class Search  My Requirements  My Planner

for selected:

**Select the course(s)** (arrow pointing to the table)  
**SELECT Enroll** (arrow pointing to the enroll button)

APPENDIX B

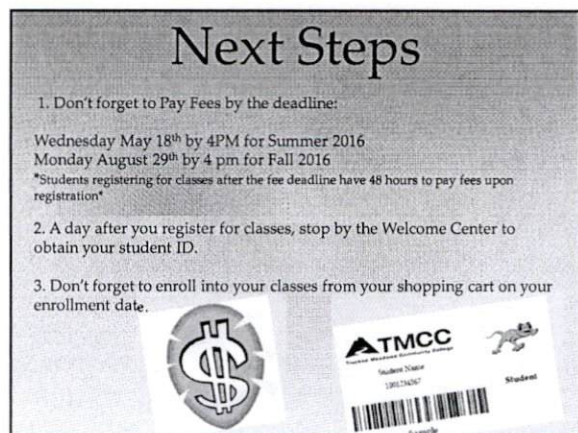
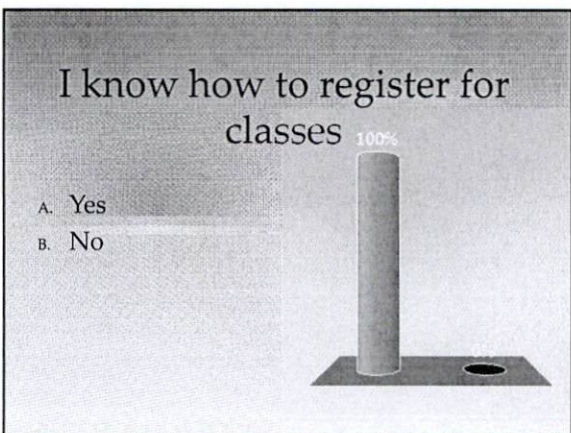
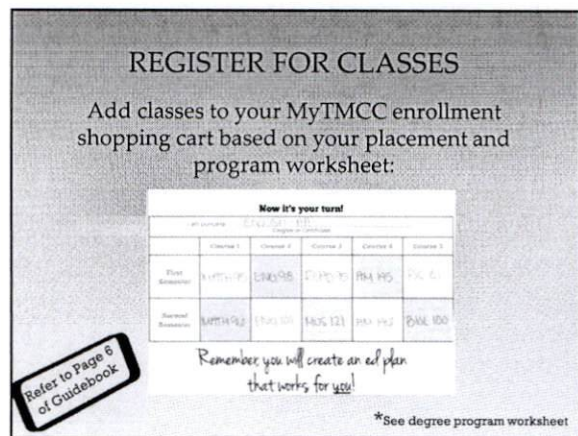
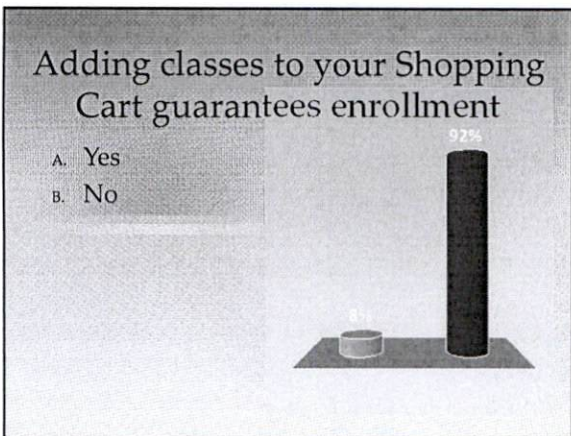
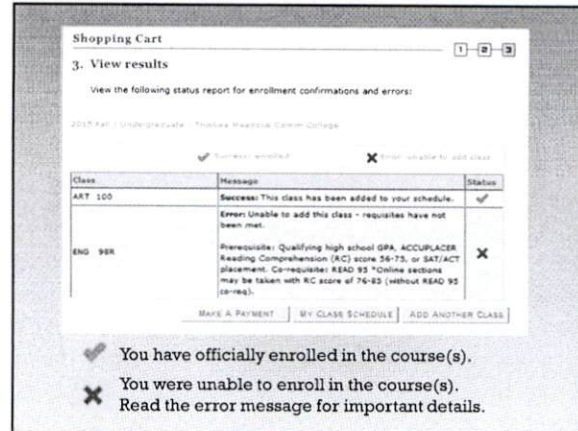
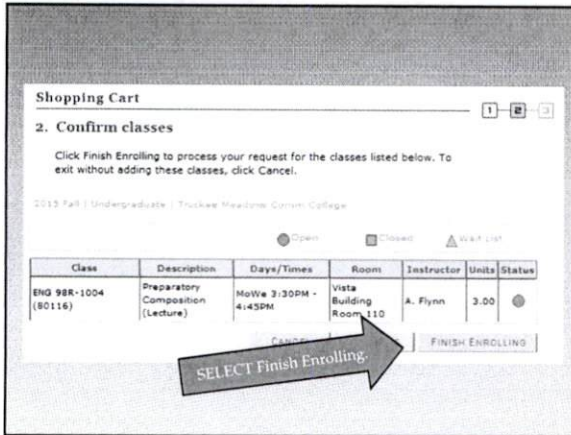

APPENDIX B

**BEFORE YOU LEAVE . . .**

- Complete the evaluation
  - Open Student Evaluation from Desktop
- Ask questions for clarification!!
- Don't forget Page 10 enrollment assistance
- Enroll into courses based on your desired goal/degree

 Welcome to  
TMCC!!



## NSHE Gateway Course Success Advisor Survey Results (5 responses from 100% of the Academic Advisors)

**Q1: Have you heard about the Gateway Course Completion plan?**

|     |
|-----|
| Yes |
| Yes |
| Yes |
| Yes |
| Yes |

**Q2: Have you read the NSHE Policy (Title 4, Chapter 16, Section 1): Placement into College-Level Courses?**

|     |
|-----|
| Yes |
| Yes |
| Yes |
| Yes |
| Yes |

**Q3: Do you provide students with math and English placement information during advising appointments?**

|     |
|-----|
| Yes |
| Yes |
| Yes |
| Yes |
| Yes |

**Q4: Do you think it is important for students to be continuously enrolled in math and English classes until they complete the sequence?**

|   |
|---|
| Yes! There are many times a student cannot continue with additional courses until they have completed their math and English courses, therefore it will save them time and effort by completing these required courses first.   |
| Absolutely. Math and English serve as foundational classes to the majority of other subjects. It is extremely important that students complete math and English as early as possible to better ensure material comprehension in other classes, especially with students placing into developmental-level courses. It behooves the student academically and financially to adhere to the NSHE gateway policy for a variety of reasons: 1) Math and English skills are foundational for many other subjects. Students need to develop these skills early in college, especially if those skills were not aptly developed in K-12. Doing so increases the likelihood of graduation with an associate's |



degree within 2-3 years. The sooner a student graduates, the sooner he/she may transfer to a university to further his/her education or enter the career field. This is economically important to both the student and the local/state/national economy. 2) Financial aid will only cover developmental courses provided they are completed within a student's first 30 attempted credits. 3) Students completing gateway courses early will likely graduate taking fewer credits, thereby avoiding the NSHE approved excess credit fee and leaving school with a smaller loan debt to pay, if loans were necessary. Lower debt and quicker access to financial stability through employment results in lower loan default rates. 3) Students completing gateway courses early will likely graduate or transfer taking fewer credits, resulting in a more efficient transfer, especially within NSHE. (This list could go on and on, so I'll stop here for now.)

Yes! It becomes difficult for many students to enroll into other general education course options along with core and emphasis requirements if students do not follow a continuous enrollment path in math and English because college level math and English courses satisfy the prerequisite requirements for these other degree requirements. Furthermore, the content provided in these courses fosters students critical and analytical thinking skills, writing and reading skills, communications skills, and so much more. These are the foundational courses that allow students to excel in their other classes, so as an advisor, or course I understand the importance of continuously enrolling in math and English.

Yes, many classes that students need to take to complete degrees depend on math and English prerequisites. If they do not complete those classes, at a certain point, they can no longer make progress towards degree completion.

Yes, math and English are often prerequisites for many of the other courses the student will need to complete. It is important to complete them first in order to do well in all of their other courses.

**Q5: Are you familiar with all possible placement options for students? Where do you get that information?**

Yes. During SOAR Part I students are given brief information about placement and it is gone over in more detail again during SOAR Part II. There are flow charts available, as well as placement handout that advisors are given. I have mine in my catalog and refer to it with my students during appointments, Quick Answer Advising, misc. workshops and for emails with students. Placement is an important aspect to their educational success and it's important that they understand their options.

Yes. Information about placement options/routes is available in the college catalog, through Testing Services, from the Math and English departments respectively, etc. Students may use a variety of test/assessment scores (ACCUPLACER, ACT, SAT, etc.), transfer work from a previous institution, or the alternative pathways program based on WCSD transcripts. Any changes made in placement scores/pathways is promptly disseminated to Academic Advising to ensure that we, as Academic Advisors, provide students with current and correct information.

I would argue that Academic Advisement is one of the only departments on campus that understand math and English placement options. Academic faculty and administrative faculty understand our knowledge in math and English placement and refer students to us regularly to review students' placement options for math and English. Our New Student Orientation program is also designed to help students understand placement. In fact, in Part II of our orientation, an orientation required for all brand new degree seeking students, the advisors spend a considerable amount of time presenting on placement and sequencing of math and English so that students are enrolled in the right math and English classes for their degrees. Our advisors do an excellent job in providing this valuable information to students. Please feel free to join us in one of our orientation sessions to see how students learn about their math and English placement options.

Yes, we get updates from Testing, A&R, the math and English departments. We also verify the accuracy of the placement flowcharts we use in orientation with math, English, and ESL prior to mass printing.

Yes, from placement grids provided by the English and math departments, from knowledge of the process and degree requirements.

**Q6: During orientations, describe the process that is used to place/register students into math and English classes.**

During SOAR Part II, we spend a good amount of time reviewing placement with our students. There are multiple slides in the presentation that help us connect with students in this regard. First, we explain how to find their test scores through their student center in order to evaluate where they have been placed. We then go into more about how to read their placement. We go over the different tests available to students, such as SAT/ACT and ACCUPLACER. We also touch on Alternate Pathways for students who have recently completed High School through Washoe County who are eligible. After this, we go into the flow charts that explain how to read and proceed with math and English. We give them examples and have them work through it with us so that they feel comfortable reading their own, and then we have them find theirs. Advisors are available to help assist students if they have questions, too. We then have them use their guidebooks to document which course they placed into as well as the course they need for their degree. With these flow charts, student are able to see which courses will lead them to their intended course outcome. We make sure that students understand their placement before moving on with the presentation and registering for classes. We also do this so that they know which courses they are eligible for, in the upcoming semester. We recommend that they take math and English during their first term.

SOAR (Student Orientation, Advising, and Registration) I online devotes an entire learning module to reviewing the "assessment and placement policy that ensures students who place at high school or above levels have an opportunity to enroll in and complete gateway college courses in mathematics and English within one academic year" as noted in Title 4, Chapter 16, Section 1.b. Students are highly encouraged to complete ACCUPLACER or submit WCSD transcripts or other acceptable assessment/placement scores before attending SOAR part II in person. During part II, advisors review this information in depth. Students receive a copy of the English/Math sequencing at TMCC along with the assessment scores needed to enroll in each respective course. We review the path options (mini-sessions, "stretch", winter/summer availability, etc.) available to students. Before we proceed further in part II, each student's placement for math and English is verified to ensure they student understands the pre-req/co-req enrollment process. Before enrollment holds are removed from student accounts, Advisors once again stress the importance of starting with math/English in the first semester and remaining continuously enrolled in those subjects until the degree-required course(s) are successfully completed. Every example of enrollment we provide to students during orientation is based on a first semester educational plan of math, English, developmental reading if required, and additional degree requirements totalling 15 credits per term.

SOAR Pt. II (SOAR is what we call our new student orientation) is where we discuss placement information with students. SOAR II is an in-person orientation. Students come in and we go over all of the information relevant to their first semester at TMCC, and placement is placement is one of the most important aspects of students' first semester, so we ensure to cover that thoroughly. We provide students with a flow chart of how the sequencing of math and English courses. Then, we review students placement scores with the students so that they understand what they are. Then, using the flow chart, we help students identify where they have placed, and teach them the appropriate way to work through the sequence until they reach the college level math and English courses needed for their degree. At the end of the orientation, we ensure they understand the importance of taking math and English courses their first semester so that they register for these courses before they leave orientation.

Students get information through Canvas in SOAR I and the placement and registration information is reiterated during SOAR II (the in-person advising/reg workshop).

Students are shown how to find their tests scores within their MyTMCC Student Center, types of tests are reviewed and scoring is reviewed to determine proper placement into math and English, this is cross referenced with their individual degree/goal and then their English and math courses are chosen. When reviewing the registration process we have students search for and register for math and English courses first.

**Q7: Do you have any concerns about full enforcement of the policy?**

No, because I feel that Academic Advising is confident with the information we provide students, and have them begin with math and English anyway.

Yes. 1) Limited staff: I know other NSHE institutions are using enrollment drop holds for "full enforcement" of the policy. We have a limited number of Academic Advisors in an office that handles orientation, advising for continuing students, international student services, early alerts, GRS, Re-Entry, major exploration, pre-professional, substitutions, graduation application reviews, transfer, assistance with financial aid regulation enforcement, CAP, and more. Every single one of these functions is extremely important. If the conversation shifts to requiring enforcement of this important policy through the use of holds, will the System be providing additional resources (i.e. funding for positions) to assist with this, especially as we are expecting another significant budget reduction in the upcoming biennium. 2) Is the System taking into consideration other gateway options related to Career/Technical (AAS) degrees (e.g. Bus 107, Eng 107, Com 113, Cul 245 etc.)? If we look at Cul 245 from the AAS-Culinary Arts degree, for example, CUL 245 is recommended to be completed in the 3rd semester of the program as other culinary courses suggested in semesters 1 and 2 are strongly encouraged by program faculty to be completed before Cul 245. 3) How is the gateway policy being evaluated in terms of degrees in which the 3-credit math requirement is satisfied through embedded curriculum in six (6) other courses?

My concerns are that some believe that academic advisors do not understand the importance of continuous enrollment in English and math. If anything, we are one of the few programs that understand this importance more than any other departments because we see how it affects students when they are not continuously enrolled. If students are not able to get into their next Math class because they did not follow our recommendations for continuous enrollment, they come to us to discuss it. Again, as student services professionals, our best interest is in the student, and getting to college level English and math as soon as they can is in their best interest. For those that believe advisors are not aware of this importance, I would encourage them to observe us in action and see how foster students abilities in progressing through their English and math sequences. If anything should be addressed with continuous enrollment into English and math, it should be the complexities involved with placement into these English and Math courses. We spend a significant amount of time helping students understand their placement, especially with math, because there are so many avenues students can take to place into English and math course, and understanding how to sift through all of that is what I feel students find most confusing. If anything, I feel our office explains these complexities well so students are leaving with a solid understanding what math and English courses they have placed into, and where the need to end with that math and English sequencing.

The staff that would be needed to manage drop holds is a concern. The advisors are already doing lots with little and I am worried that if we move to the holds without additional staffing that we would not be as accessible to students.

No, because we already encourage students to complete math and English first. There will be no change in our process. My concerns are with a drop hold policy that doesn't allow for students to change sections or adjust their schedule during the first week of school without seeing an Advisor to remove a hold to allow those adjustments. I think that is inconvenient to students and may have students feel that they do not have options to change their schedules which could lead to poor performance.

## Gateway Course Success Policy Communications

### Canvas/Email/e-newsletter:

IMPORTANT: Beginning Fall 2016, the Board of Regents for all Nevada colleges and universities is requiring students to complete their college-level English and math courses within their first year of school.

What this means for you: If you are working towards a degree or certificate, you will need to be continuously enrolled in English and math until completing the college-level classes required for your program. This may include: ENG 101, ENG 113, BUS 106, BUS 108 for English and MATH 120, MATH 126, COT 110, BUS 117 for Mathematics.

For more information, please see the [Board of Regents Policy \(Title 4, Chapter 16, Section 1\)](#).

### Alt Pathways letter to WCSD students: Add a sentence or two to the existing letter

April 13, 2015

fld\_FIRST\_NAME fld\_LAST\_NAME  
 fld\_ADDRESS1  
 <?if:fld\_ADDRESS2!="?">fld\_ADDRESS2  
 <?end if?>fld\_CITY, fld\_STATE fld\_POSTALEC

Dear fld\_FIRST\_NAME,

This letter is to inform you that based on Truckee Meadows Community College (TMCC) Alternate Pathways placement, your Washoe County School District un-weighted grade point average of 3.0 or higher makes you eligible to enroll in one of the following English courses:

ENG 101 (Recommended READ 135)

--OR--

ENG 113 (Recommended Non-Native READ 135)

<?if:C.MATH\_TEST\_COMPONENT='WHSM'?>

With your Algebra II Semester 2 grade, you are also eligible to enroll in the one of the following Math courses:

Math 120

--OR--

Math 126

end if

Plan to register in English and math in your first semester. You will receive additional information on registration and placement during [SOAR](#) (Student Orientation, Advising and Registration).



If you have further questions regarding your TMCC Alternate Pathways placement, please contact the TMCC Academic Advisement Center at 775-673-7062 or [advisement@tmcc.edu](mailto:advisement@tmcc.edu)

Sincerely,

Natalie Brown  
Program Director  
Academic Advising and Transfer Center

**WCSD Counselors: Flyer to give to Patty for the WCSD Counselor Breakfast**

The NSHE Board of Regents is requiring students to complete their college-level English and math courses within their first year of school. Students will be placed into English and math courses through multiple measures including: Alternate Pathways, Accuplacer, ACT, SAT, PARCC, or Smarter Balanced test scores.

Students who place into remedial-level coursework, will be expected to continuously enroll in English and math until completion of their college-level classes.

For more information, please see the [Board of Regents Policy \(Title 4, Chapter 16, Section 1\)](#).

**COURSE DESCRIPTIONS FROM  
2014-2015 CATALOG**

**MATH 92: Algebra Review**

Provides a review of algebra that is necessary in the subsequent course.

**Note (not in catalog):**

This is not a course that is part of the math sequence and cannot be used as a prerequisite for any other course. Its purpose is to create the "stretch" courses listed in this brochure.

**MATH 95: Elementary Algebra**

Prerequisite: A grade of C or better in Math 93 or equivalent or qualifying ACCUPLACER, ACT/SAT test results. A graphing calculator may be required for this course. A first course in algebra. Topics covered include the fundamental operations on real numbers, first degree equations, inequalities in one variable, polynomials, integer exponents, solving quadratic equations by factoring.

**MATH 96: Intermediate Algebra**

Prerequisite: A grade of C or better in Math 95 or equivalent or qualifying ACCUPLACER, ACT/SAT test results. A graphing calculator may be required for this course. A second course in algebra. Topics covered include: solving quadratic, rational and radical equations, simplifying rational and radical expressions and complex numbers, and solving application problems.

**MATH 120: Fundamentals of College Mathematics**

Prerequisite: A grade of C or better in Math 96 or 97 or equivalent or qualifying ACCUPLACER, ACT/SAT test results. A graphing calculator may be required for this course. Mathematical concepts particularly relevant to informed and aware citizenship in modern society. Topics covered include functions, graphs, problem solving, topics in finance, geometry, probability and statistics. Satisfies UNR core curriculum.

**MATH 126: Pre-Calculus I**

Prerequisite: A grade of C or better in Math 96 or 97 or equivalent or qualifying ACCUPLACER, ACT/SAT test results. A graphing calculator may be required for this course. The study of equations and inequalities involving radical, rational, quadratic or absolute value terms. Also includes polynomial, rational, exponential and logarithmic functions, their graphs and applications.

**MATH 127: Pre-Calculus II**

Prerequisite: A grade of C or better in Math 126 or equivalent or qualifying ACCUPLACER, ACT/SAT test results. A graphing calculator may be required for this course. Continuation of Math 126. Includes the study of circular functions, their graphs and applications; analytic trigonometry; the coordinate geometry of lines and conics; solving systems of equations; matrices; mathematical induction. The combination of Math 126 and Math 127 is equivalent to UNR's Math 128.

**TMCC MATH DEPARTMENT AND BOARD  
OF REGENTS POLICIES REGARDING  
PREREQUISITES**

ACCUPLACER, ACT and SAT test scores are accepted for placement into TMCC math classes, provided that these scores are not more than two years old. If a student's test scores are more than two years old and the student has not completed an appropriate pre-requisite class with a grade of "C" or better within the past two years, the student must re-test to place into a math class.

TMCC is an EEO/AA (equal opportunity/affirmative action) institution and does not discriminate on the basis of sex, age, race, color, religion, disability, national origin or sexual orientation in the programs or activities which it operates.



**FALL 2016**

**MATH DEPARTMENT  
FAST TRACK OPTIONS**

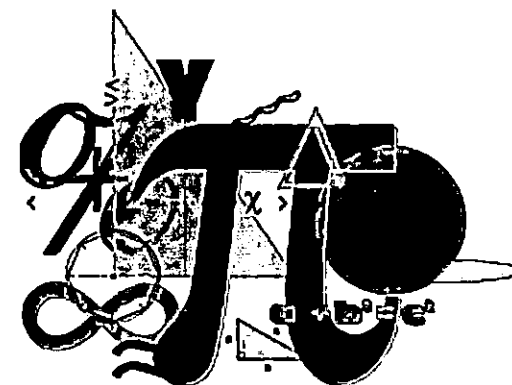

**COMPLETE YOUR MATH  
REQUIREMENTS SOONER!**

Mathematics  
Truckee Meadows Community College  
7000 Dandini Blvd. Vista B200  
Reno, NV 89512  
775-673-7181



**MATH 95/MATH 96  
MINI SESSIONS  
(6 credits)**

Students must register for both courses at the beginning of the semester. Those who score at least a C in Math 95 proceed into Math 96. The section numbers for these mini session courses are 5002, 5201.

Please refer to schedule for dates and times.

**MATH 96/MATH 126  
MINI SESSIONS  
(6 credits)**

Students must register for both courses at the beginning of the semester. Those who score at least a C in Math 96 proceed into Math 126. The section numbers for these mini session courses are 5003, 5004.

Please refer to schedule for dates and times.

**MATH 126/MATH 127  
MINI SESSIONS  
(6 credits)**

Students must register for both courses at the beginning of the semester. Those who score at least a C in Math 126 proceed into Math 127. The section number for this mini session courses are 5006.

Please refer to schedule for dates and times.

**STRETCH MATH 95/MATH 96  
(7 credits)**

This is a "stretch" version of the Math 95/ Math 96 mini sessions courses. Students with Arithmetic ACCUPLACER scores 60 to 79 will be accepted. Students must register for Math 92, Math 95 and Math 96 in which all have the same section number. This is seven credit class meets Monday through Thursday. Those who score at least a C in Math 95 proceed into Math 96. The section numbers for these stretch courses are 9502, 9503, 9504.

Please refer to schedule for dates and times.

**STRETCH MATH 120  
(4 credits)**

Qualifying students must have a College Level Math score of 50 on the ACCUPLACER exam, or an SAT Math score of 500, or an ACT Math score of 22. Note that those exam scores would also qualify a student for a normal 120 section. Students are also eligible for a stretch section of Math 120 with a B or better in Math 95 within the last 2 years. The section numbers for these stretch courses are 9501 and 9507. Students must register for Math 92 and Math 120 with the same section number.

Please refer to schedule for dates and times.

**STRETCH MATH 96D/126E  
(4 credits)**

This course is a four credit, five hour per week "stretch" course that meets three days per week. Students must register for both Math 96D-9508 and Math 126E-9508. Please note that Math 96D is not a course that is part of the math sequence. Its purpose is only to create this "stretch" course. Those who score at least a C in Math 96D can continue in Math 126E. To qualify for this stretch class a student must have one of the following scores:

- ◆ ACCUPLACER: Elementary Algebra 105 and College Level Math 39 to 54
- ◆ SAT: 490
- ◆ ACT: 21

Please refer to schedule for dates and times.

**3 OUT OF 2  
PEOPLE  
HAVE  
TROUBLE  
WITH  
FRACTIONS**

**TRUCKEE MEADOWS COMMUNITY COLLEGE**

**RESOURCES SUPPORTING IMPLEMENTATION OF TITLE 4, CHAPTER 16, SECTION 1**

**DIRECTIONS:** Indicate the existing and new resources that will be dedicated to your action plan for implementing the provisions of Title 4, Chapter 16, Section 1. You may edit the template as you see fit to appropriately represent institutional resources dedicated to implementation.

**PERSONNEL**

|                              | Existing  |           |           |           | New*      |           |           |           |
|------------------------------|-----------|-----------|-----------|-----------|-----------|-----------|-----------|-----------|
|                              | Headcount |           | FTE       |           | Headcount |           | FTE       |           |
|                              | Full-time | Part-time | Full-time | Part-Time | Full-time | Part-time | Full-time | Part-Time |
| Faculty - mathematics**      | 15        | 23        | 12.9      | 8.5       | 6         | 0         | 4.8       | 0.0       |
| Faculty - English**          | 15        | 29        | 11.0      | 9.1       | 6         | 0         | 4.8       | 0.0       |
| Advisors                     | 5         | 0         | 5.0       | 0.0       | 2***      | 0         | 2.0       | 0.0       |
| A&R Personnel to work on AAR | 1         |           |           |           | 1***      | 0         | 1.0       | 0.0       |
| Other (please indicate)      |           |           |           |           |           |           |           |           |
| Other (please indicate)      |           |           |           |           |           |           |           |           |

\*New hires or reallocation of existing positions to support implementation of T4, Ch 16, Section 1 and institutional action plan

\*\*Faculty who teach gateway courses, FTE figure should be for the portion of their time dedicated to gateway course instruction

\*\*\* Funding requested and approval pending.

**OTHER COSTS OR RESOURCES**

Software or Programming Support - Please indicate other costs such as software or programming support to provide intrusive advising, and other automation of the enrollment requirements or continuous enrollment

|                                  | 2016-17    | 2017-18    | 2018-19 |
|----------------------------------|------------|------------|---------|
| Other Costs (student incentives) | \$3,000.00 | \$2,000.00 |         |
| Other Costs (please indicate)    |            |            |         |
| Other Costs (please indicate)    |            |            |         |
| Other Costs (please indicate)    |            |            |         |

New FT hires include 4 tenure track and 2 FT temporary

New FTE Calculations: 4/5 of new FT hires' work load will be dedicated to gateway courses.

|                                   | 2016-17 | 2017-18 | 2018-19 |
|-----------------------------------|---------|---------|---------|
| Other Resources (please indicate) |         |         |         |
| Other Resources (please indicate) |         |         |         |
| Other Resources (please indicate) |         |         |         |
| Other Resources (please indicate) |         |         |         |

**WNC**

**Institutional Gateway Course Action Plan**

**WESTERN NEVADA COLLEGE**  
**A Plan to Meet Board Policy**  
**Title 4, Chapter 16, Section 1**

**Preamble:**

While considering the calculations necessary to complete the data benchmarking and projections for the next two years we took into consideration data from multiple sources, including: existing data provided in the benchmarking worksheet, 2014-15 Remedial Placement & Enrollment Report, WNC AS program review, WNC 2015 mission fulfillment and strategic plan indicators report, and additional data provided by WNC Institutional Research. We recognize that as an institution we have many tools at hand to address this policy change and attempt to meet the Board's expectations. We considered those tools to be divided into two categories. Academic tools that are potentially at our disposal include: increased section offerings, increased online offerings to provide student scheduling flexibility, and co-requisite offerings. Student services tools might include increased focus on counseling and advising, and registration holds.

As we worked through the data sets described above, we discovered a potential problem. I'll use rough numbers to describe this problem here. Approximately 50% of our entering students place into remedial math; 50% into a gateway level math. For the 50% in gateway level math we have no excuse if we cannot register them in a gateway course in their first year. Sufficient space is available in existing gateway courses to accept those students who have not been taking a gateway course, so this is primarily an advising issue and something we can and will address.

For the 50% who place into remedial math we have a larger problem. The historic passing rate in those courses is approximately 60%; in other words 30% of our students (60% of 50%) should have passed a remedial course in fall and be prepared to take a gateway course in spring. However, the WNC Fall to Spring retention rate is approximately 70%. Extrapolating to this population because I do not have access to data specific to this group, would imply that 30% of the students who passed a remedial course in Fall won't be on campus in Spring to register for a gateway course. Despite our best efforts to place, register and instruct this group of students in adherence to Title 4, Chapter 16, Section 1, some external force will prevent them from returning and taking a gateway course in the Spring. Similar numbers exist for English.

Roughly 9 to 10% of WNC's baseline students will not take a gateway course during their first year for systemic reasons that are beyond the resolution of the tools we potentially have at our disposal. They won't be here for reasons that lie beyond the scope of advising, academics, or registration to address. If we flipped every switch, pulled every lever, and were operating in a perfect world where life didn't happen to students, a 90% enrollment rate is the best we could hope for in the absence of a major retention program.

## Policy Framework

### 2.a. Exemption from Remedial Instruction.

Because of the timing of the new Board policy, Fall 2016 will be the first opportunity for WNC to implement a placement procedure for the exemption from remedial instruction that adheres to Board policy. Such a procedure has been approved at WNC and will be adhered to for all incoming Fall 2016 students.

### 2.b. Placement of Students without an Exemption from Remedial Instruction.

A placement protocol which meets the state Board policy has been in place at WNC for several years. Students placed into remedial English take ENGL 099 and then move to ENGL 101. Students who took and passed ENGL 099 prior to Fall 2015 were not likely to register for ENGL 101 the following semester. A review of this issue suggested that the 6 credit hour ENGL 099 was exhausting for our students, and no amount of advising could convince the majority of them to remain continuously enrolled into ENGL 101. We've redesigned ENGL 099 into a four credit course and anticipate greater continuous enrollment into ENGL 101 as a consequence.

Students placed into remedial Math can follow three paths depending on their anticipated major. Students in non-STEM majors, who take MATH 120 as their gateway course, may take MATH 095 then MATH 120. It appears that very few students take this option and we will need to reconsider our advising efforts in this regard. Students in STEM majors, who take MATH 126 as their gateway course, may (in the worst case scenario) take MATH 095, MATH 096 and then MATH 126, OR they can take MATH 095 and then the MATH 96D/126D co-requisite course.

Placement in ENGL for students who do not have the exemption defined in section 2.a. has been, and will continue to be, by Accuplacer exam. Placement in MATH for students who do not have the exemption defined in section 2.a. has been, and will continue to be, by a combination of various placement test scores and/or high school mathematics course selection and grades.

### 3. Continuous Enrollment.

WNC has routinely advised entering students towards continuous enrollment in math and English courses, when appropriate, as a foundational part of our Project Graduate. This has not been an institutional policy, but rather an effort of the student services area. Beginning with the Fall 2016 class, WNC will implement a policy which requires continuous enrollment until completion of the appropriate gateway course. The policy statement has been developed, along with plans for implementing the procedures and informing students as described herein.

## Policy Statement on Placement and Completion

WNC is committed to student success and facilitating course and degree completion. All new degree/certificate seeking students will be required to attend a new student orientation, take placement tests or submit alternative test scores, and meet with a WNC counselor. Students must enroll in math and English courses during their first semester and must be continuously enrolled in mathematics and English courses until college level courses (courses numbered 100 or higher) have been completed in both areas.

### **Enforcement Measures**

While WNC has, through Project Graduate, routinely advised students towards continuous enrollment in core courses, this has not been institutional policy; in the absence of a policy, there can be no enforcement. All first time in college students, those in Project Graduate, have an advising hold placed on them for the entering semester that requires they meet with an advisor prior to registration. Implementing specific registration holds for math and English on all entering students appears to be technically possible but, based on reports from institutions doing this now, the additional labor required to set, evaluate, and clear such holds is beyond what WNC's Advising or Admissions and Records offices could support. We have additional concerns about the impact of registration holds on CTE and part-time students.

If the budget improves with the next biennium, we will make every effort to introduce advising holds for students with remedial placement beginning Fall 2017, and expand this to all entering students in Fall 2018.

### **Advising and Student Outreach**

Since WNC has been running Project Graduate for several years, our counselors are familiar with leading our entering students into a pathway that includes continuous enrollment in core courses. Since this has not been an institutional policy, the counselors have used their judgement to alter this pathway when the student's circumstances suggest that continuous enrollment would most likely not lead to student success.

Currently, all first time students who apply for admission to WNC are routed into the mandatory services provided by the Project Graduate program. As soon as new students' applications for admission are processed, their names are sent to Counseling and imported into a Project Graduate tracking spreadsheet by a peer mentor in the Counseling office and we begin providing services. A peer mentor calls each student, welcomes him/her to the college, and informs the student that there are three important steps to be completed before



registering for his/her first semester. The student will need to take a placement test, attend a new student orientation, and meet with a counselor to develop an educational plan, review placement test scores and determine the first semester class schedule. The peer mentor explains each step in detail to the student, answers any questions, and then schedules the student for a placement test and for an orientation date.

There are a few new enhancements to the Project Graduate program that will more clearly define the counselor's role in supporting the mission of completion in the Gateway courses. First, each Project Graduate student will now be assigned a specific advisor. This advisor will be responsible for meeting with this student once a semester and guiding them into a placement and schedule to complete gateway math and English courses in their first year. The advisor will monitor their students' progress towards completion of gateway courses and advise scheduling corrections accordingly. The advisor will retain all communications with the student, both those generated by Counseling and those created by our early alert system. By compiling this data across all counselors, we will be able to identify systemic issues that prevent students from completing gateway courses. When counselors meet with each student to plan their classes for the next semester, they will revisit the student's educational plan and get them back on track to finish their gateway courses if necessary. Second, additional significance will be placed on completing gateway courses in the Orientation program. Counselors will inform incoming students of the importance the gateway courses hold in their educational plan and that it will be a monitored expectation that they work towards completing these courses within the first year.

### **Communication Strategies**

Messaging of the Board policy will be provided to system and high school administrators, high school guidance counselors, high school students, and non-traditional students through a variety of means. Communication with system administrators will come through the WNC Institutional Advisory Council. All service area system superintendents serve as either voting or ad-hoc members of our IAC. Communication with school administrators and guidance counselors will occur through channels already in place through WNC's Jump Start program. We work with these administrators through multiple touches each semester, so we have access to provide and reinforce that message. The Board policy was also discussed during our most recent CTE open house for high school guidance counselors.

WNC's application of Board policy will be presented to high school students through the advising process for Jump Start, and through our Bridge to Success program which works with seniors in every high school in our service area. In addition to placement on the WNC webpage, the academic program guide for each year, and the course schedule for each semester, WNC's application of the Board policy will be added to our freshman orientation process.

**WESTERN NEVADA COLLEGE**

**RESOURCES SUPPORTING IMPLEMENTATION OF TITLE 4, CHAPTER 16, SECTION 1**

**DIRECTIONS:** Indicate the existing and new resources that will be dedicated to your action plan for implementing the provisions of Title 4, Chapter 16, Section 1. You may edit the template as you see fit to appropriately represent institutional resources dedicated to implementation.

**PERSONNEL**

|                         | Existing  |                 |           |           | New* See note 1 |           |           |           |
|-------------------------|-----------|-----------------|-----------|-----------|-----------------|-----------|-----------|-----------|
|                         | Headcount |                 | FTE       |           | Headcount       |           | FTE       |           |
|                         | Full-time | Part-time       | Full-time | Part-Time | Full-time       | Part-time | Full-time | Part-Time |
| Faculty - mathematics** | 6         | 6               | 2.8       | 1.3       | 2               | 1         | 1.6       | 0.4       |
| Faculty - English**     | 6         | 9               | 2.3       | 2.3       | 1               | 2         | 0.8       | 0.4       |
| Advisors                | 4         | 2 @ .5 FTE each | 2.0       | 0.5       | 2               | -1        | 1.5       | -0.1      |
| Other (please indicate) |           |                 |           |           |                 |           |           |           |
| Other (please indicate) |           |                 |           |           |                 |           |           |           |
| Other (please indicate) |           |                 |           |           |                 |           |           |           |

See note 2

\*New hires or reallocation of existing positions to support implementation of T4, Ch 16, Section 1 and institutional action plan

\*\*Faculty who teach gateway courses, FTE figure should be for the portion of their time dedicated to gateway course instruction

1. New full-time hires in math and English started in Fall 2015 as part of an internal WNC effort to increase gateway completion rates. Hence they are also counted as part of the existing faculty.

2. Under our current model Advisors spend approximately 50% of their time working with gateway and below students. Our revised model will require they spend approximately 75% of their time with that same group.

**OTHER COSTS OR RESOURCES**

Software or Programming Support - Please indicate other costs such as software or programming support to provide intrusive advising, and other automation of the enrollment requirements or continuous enrollment

|   | 2016-17 | 2017-18 | 2018-19 |
|---|---------|---------|---------|
| Advising support software, developed in-house |         |         |         |

revised  
4.18.16